

SCHNITT 1-1, 1:50

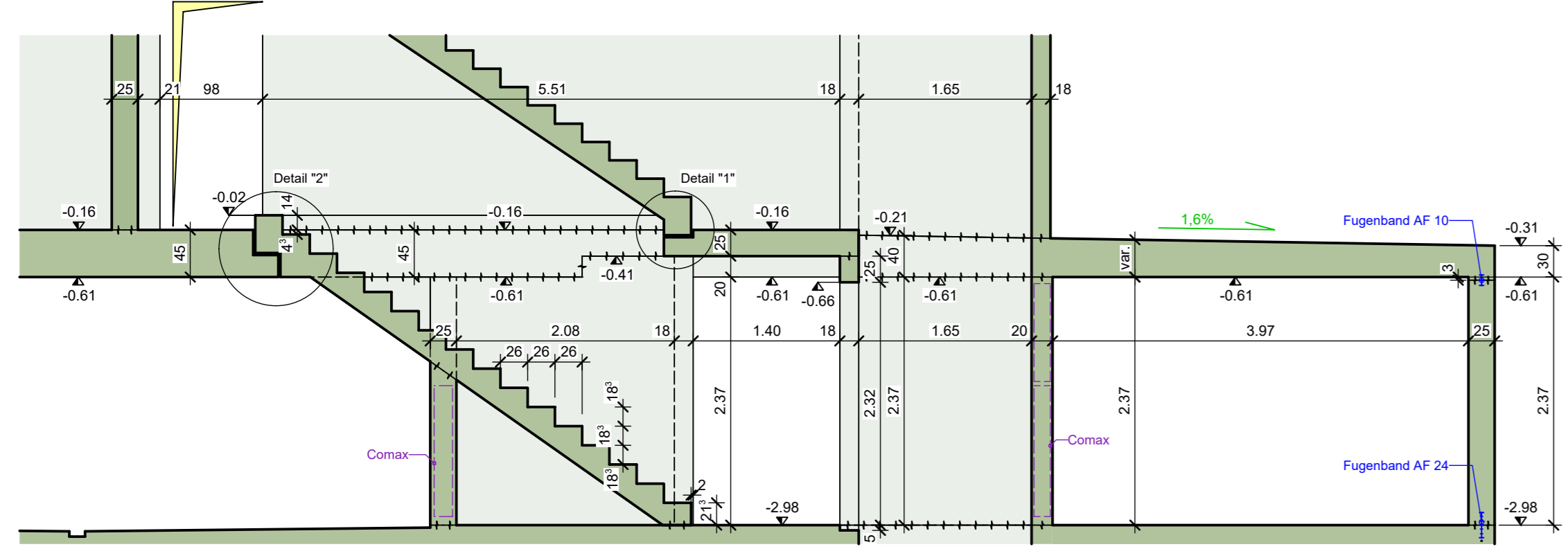

SCHNITT 2-2, 1:50

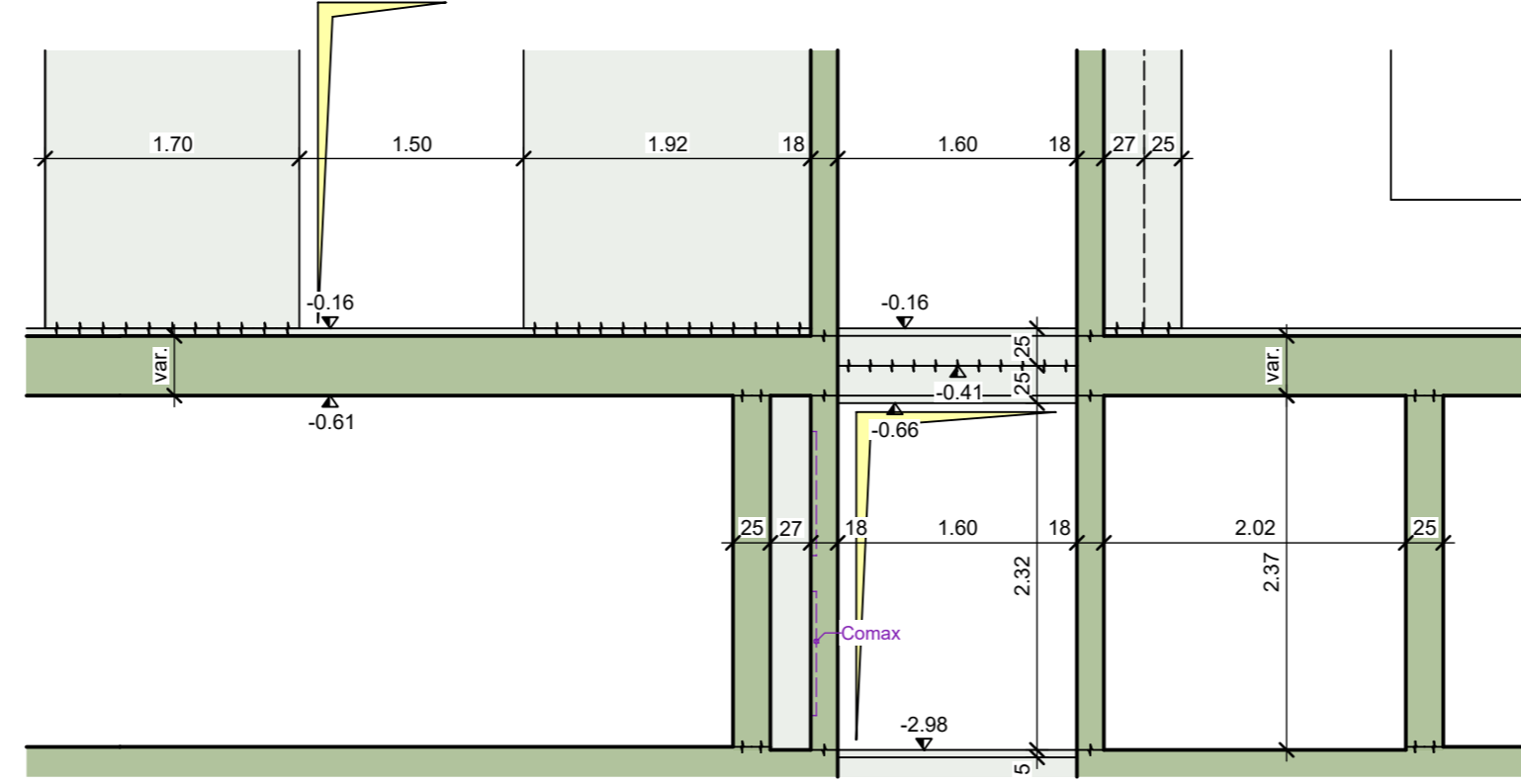

SCHNITT 3-3, 1:50

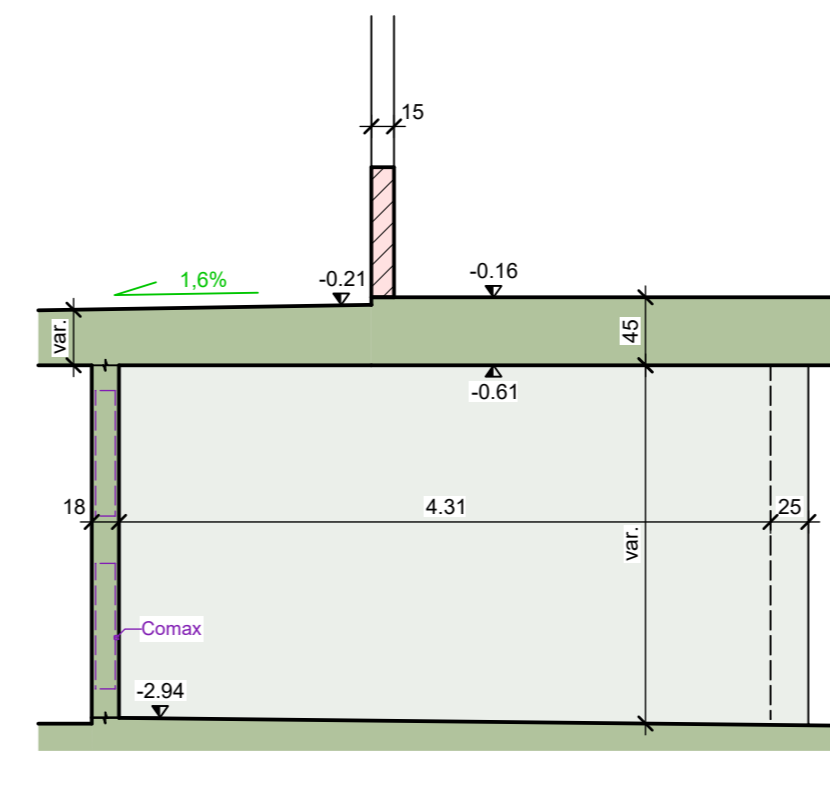

SCHNITT 4-4, 1:50

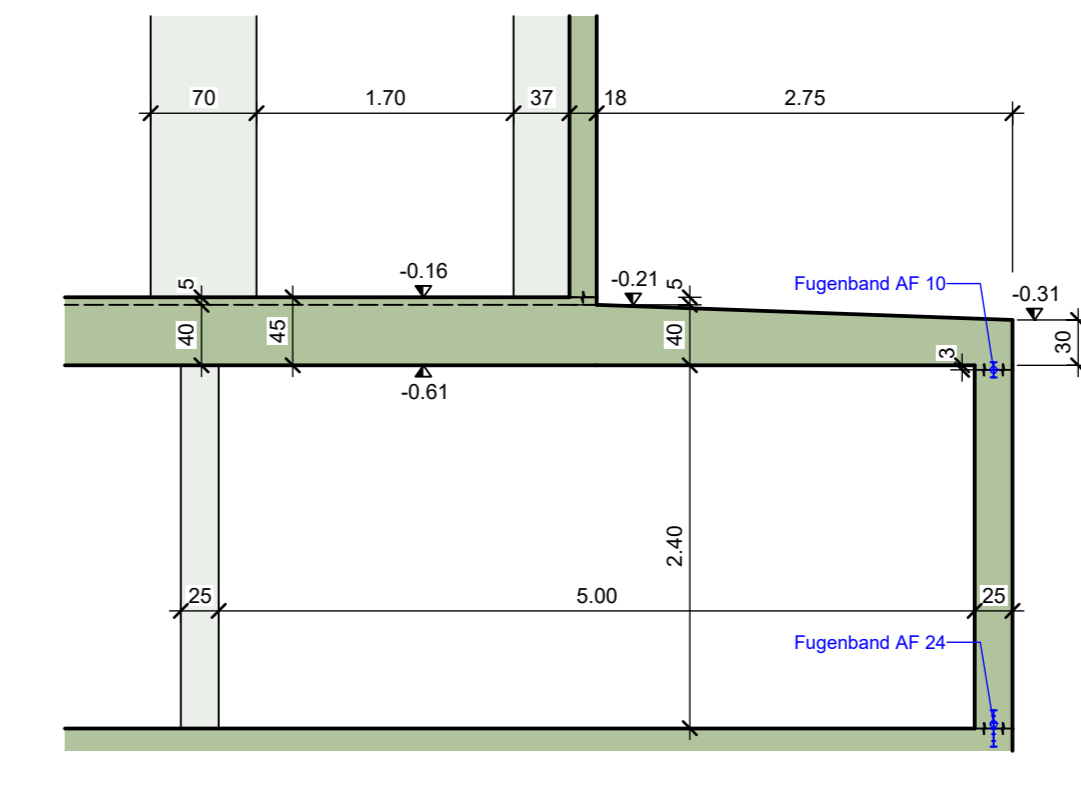

SCHNITT 5-5, 1:50

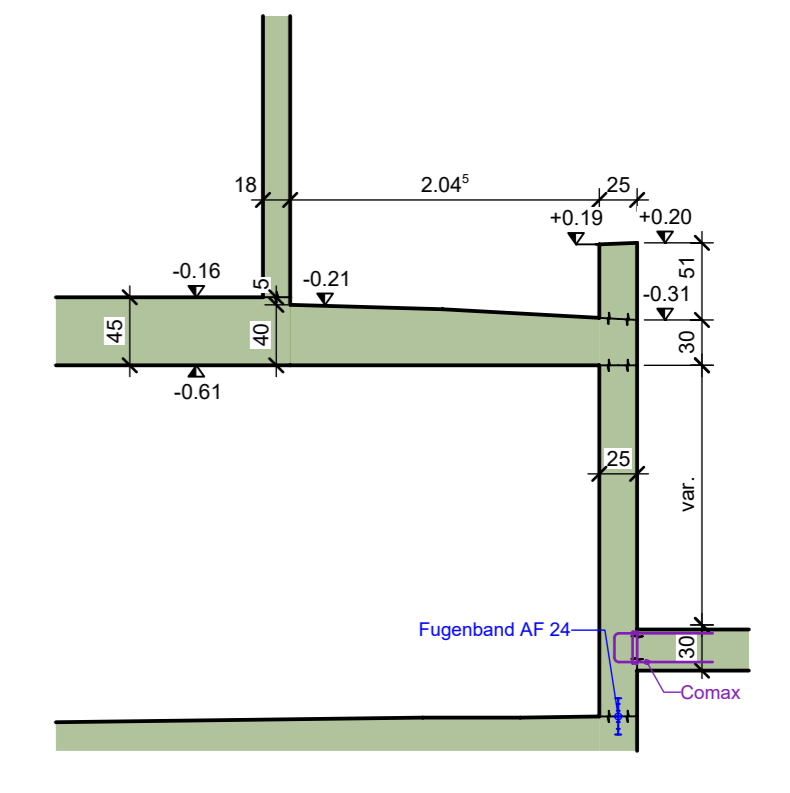

GRUNDRISS, 1:50

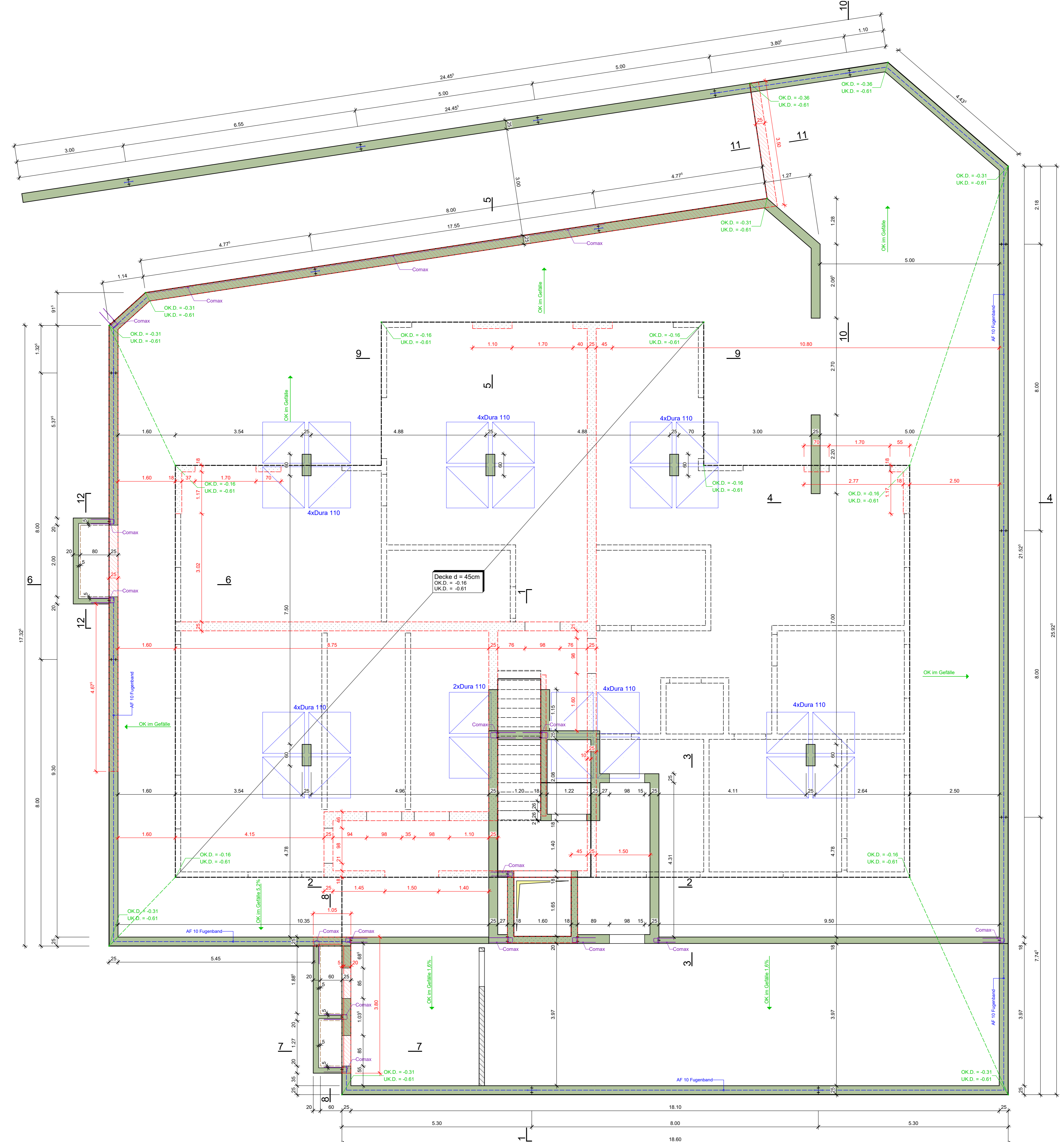

SCHNITT 9-9, 1:50

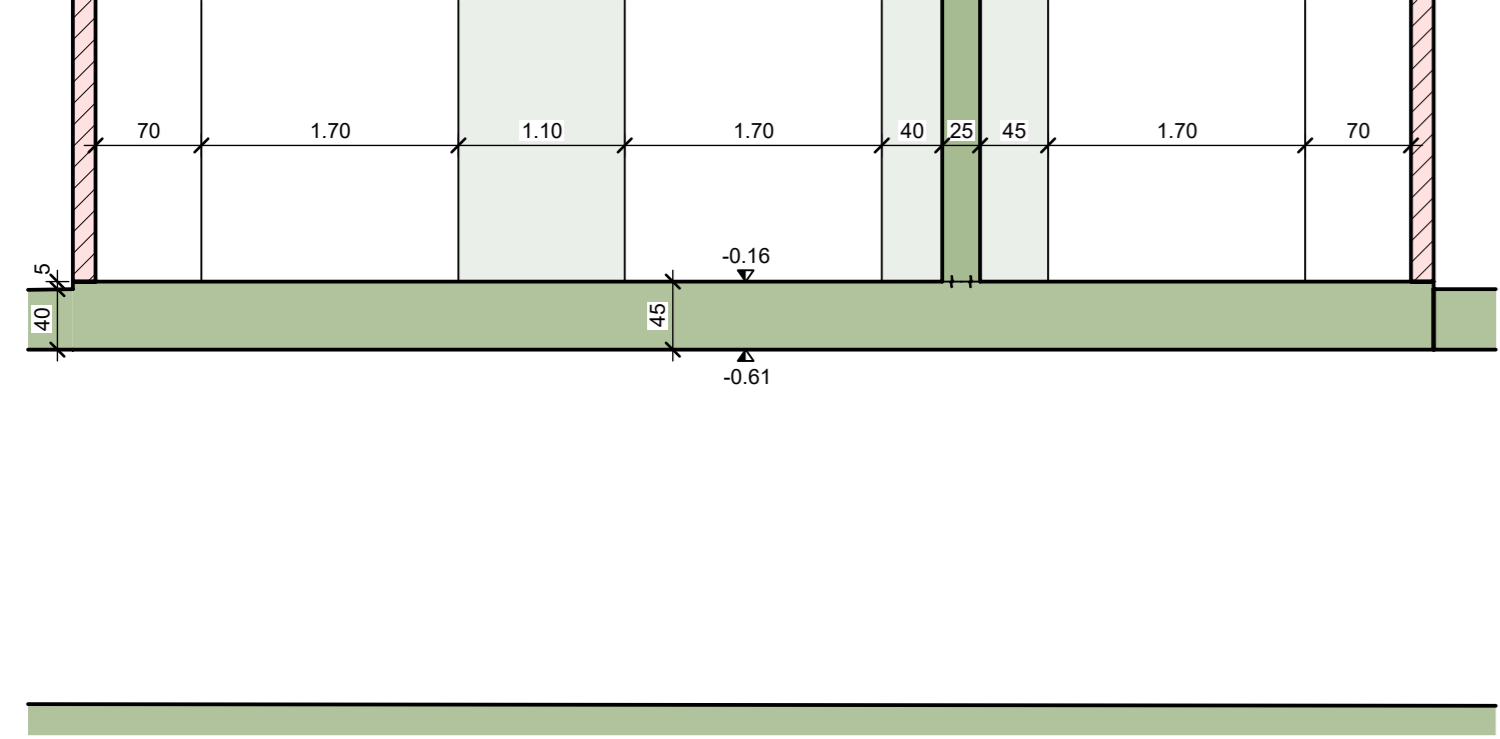

SCHNITT 10-10, 1:50

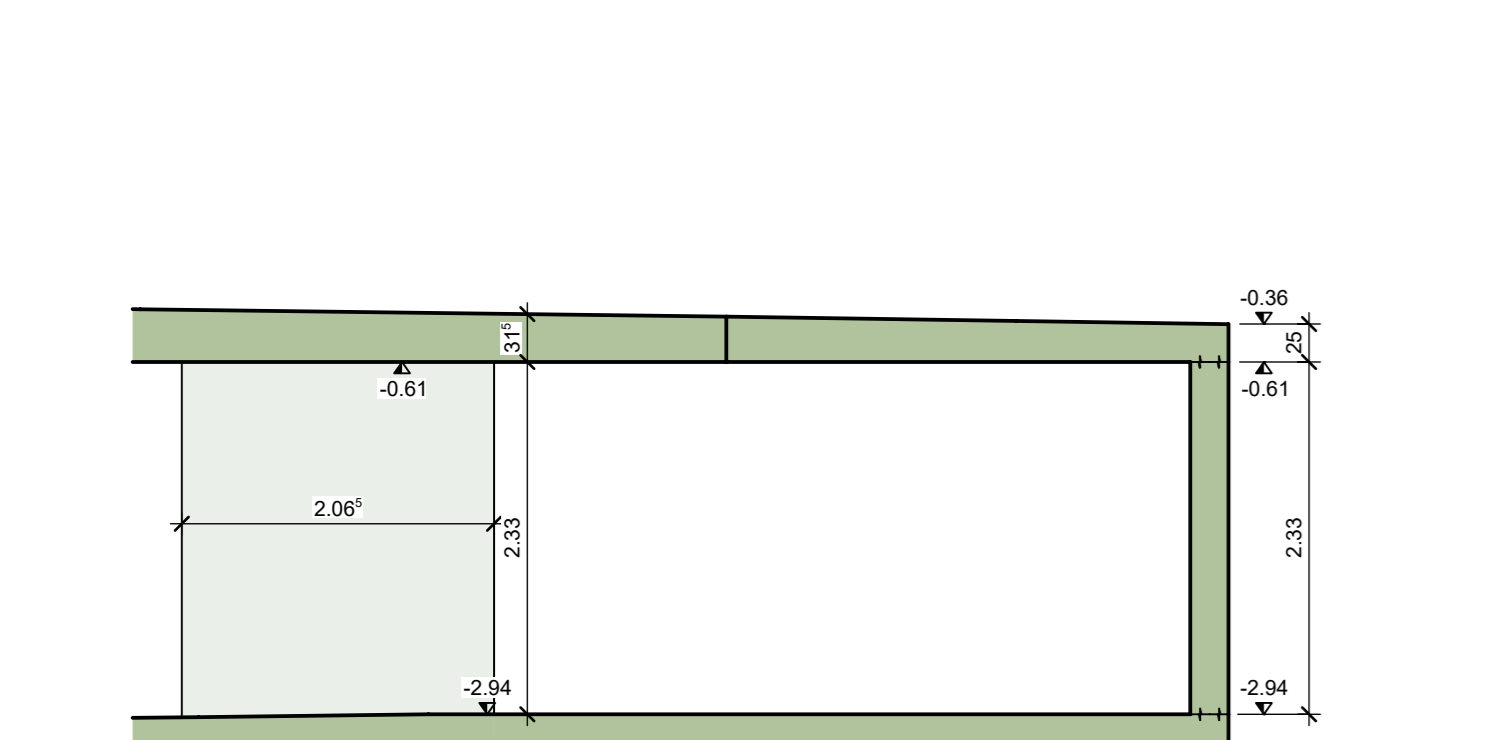

SCHNITT 11-11, 1:25

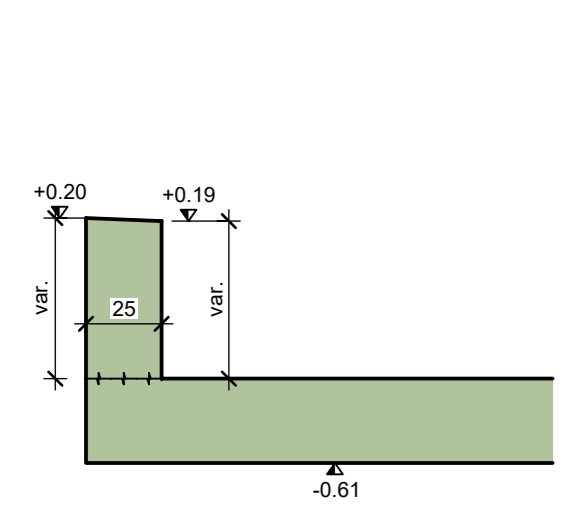

Detail "1", 1:20

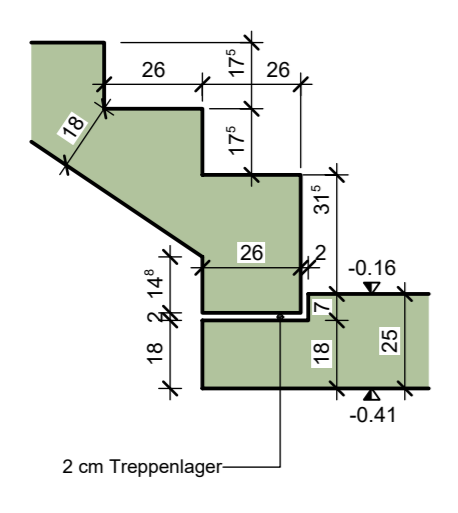

Detail "2", 1:20

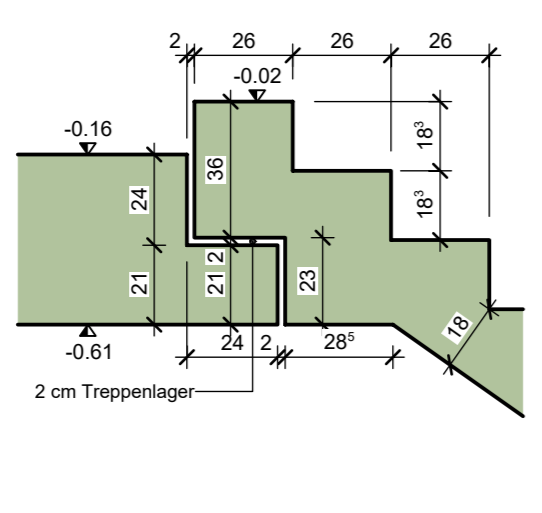

SCHNITT 6-6, 1:25

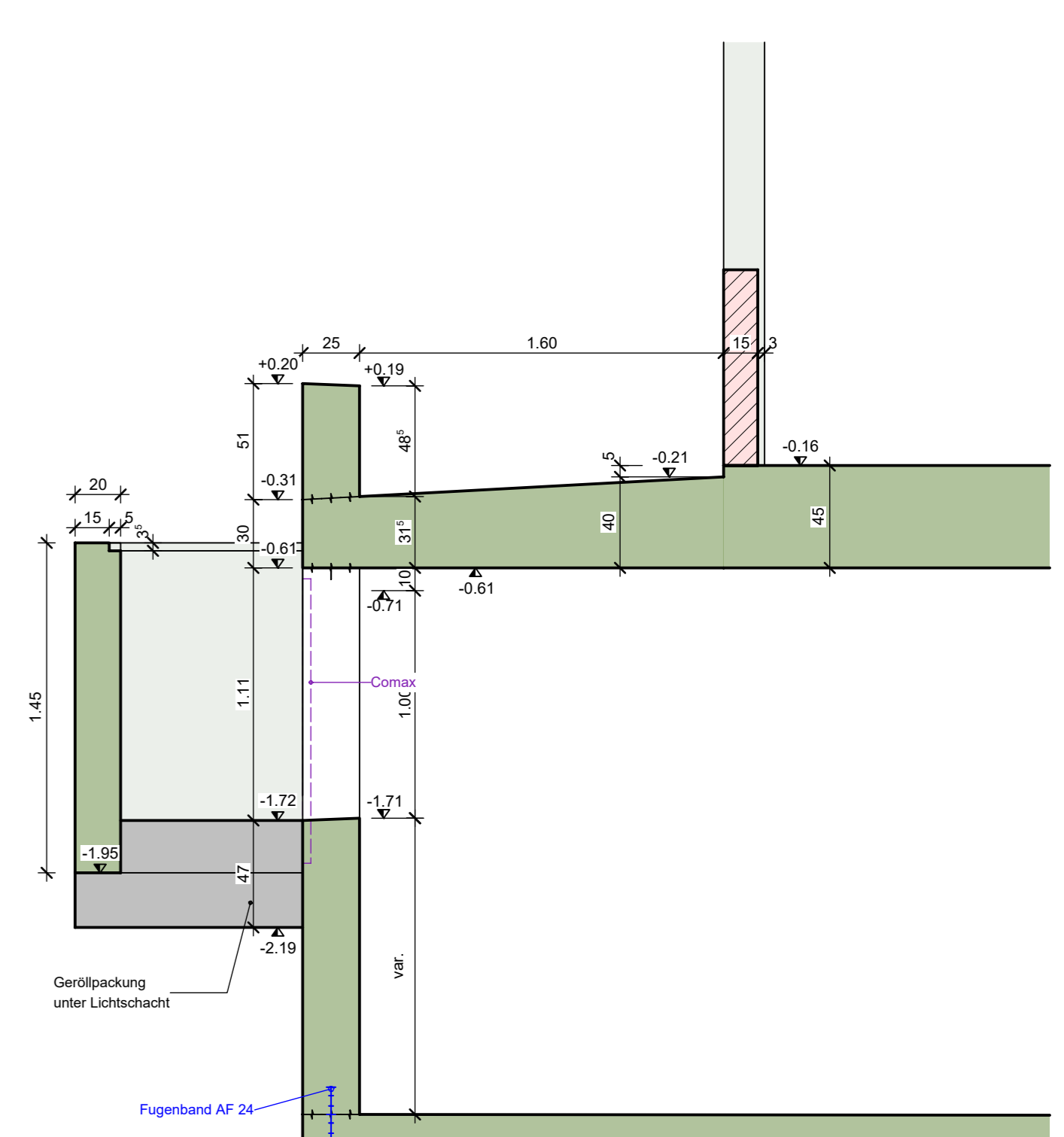

SCHNITT 12-12, 1:25

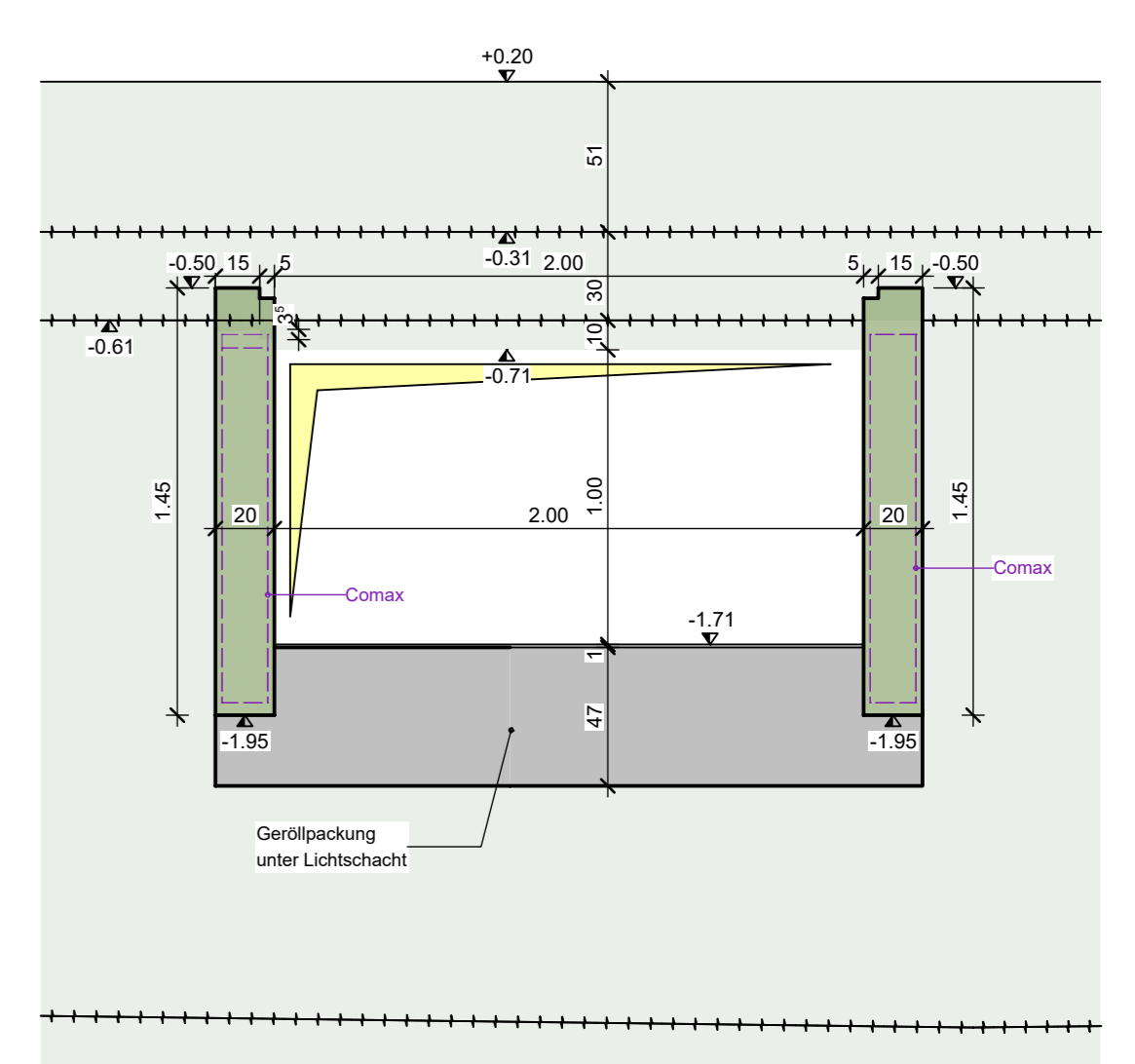

SCHNITT 7-7, 1:25

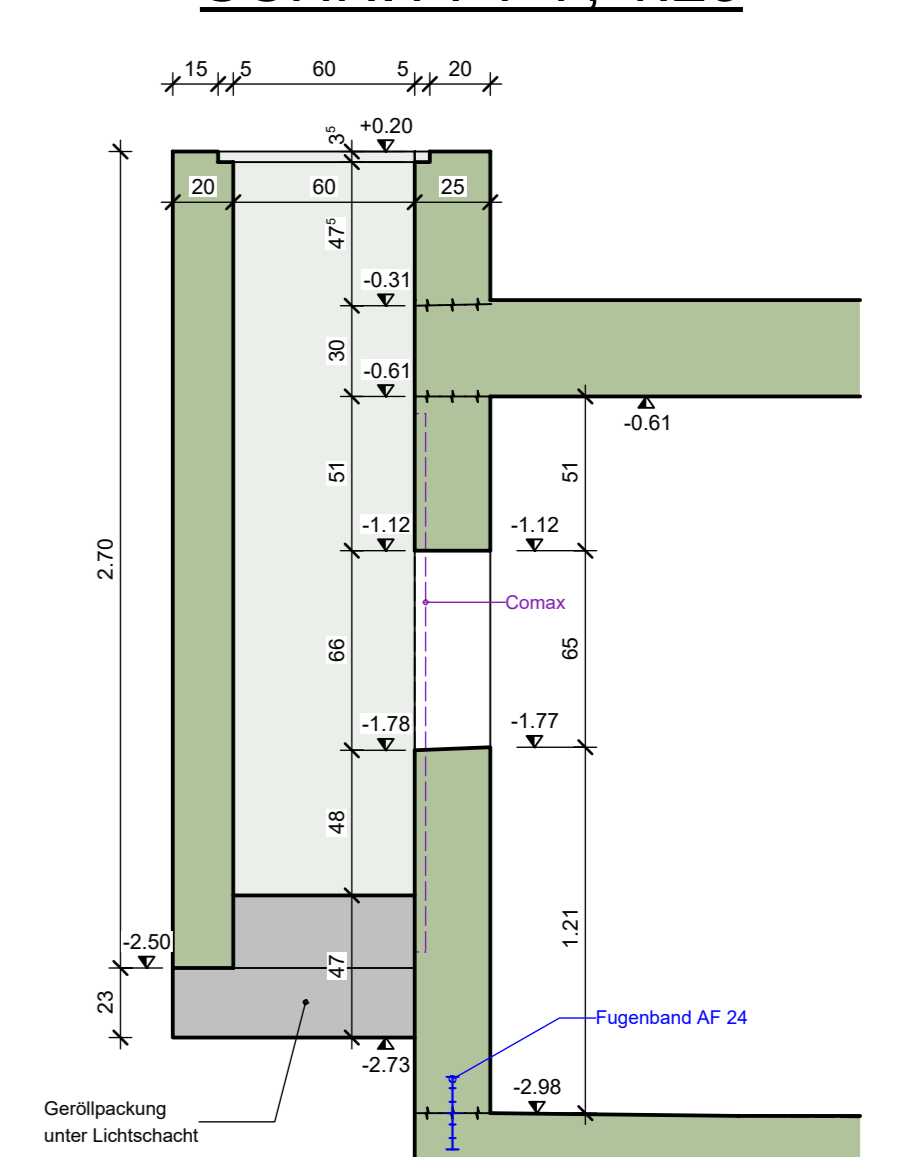

SCHNITT 8-8, 1:25

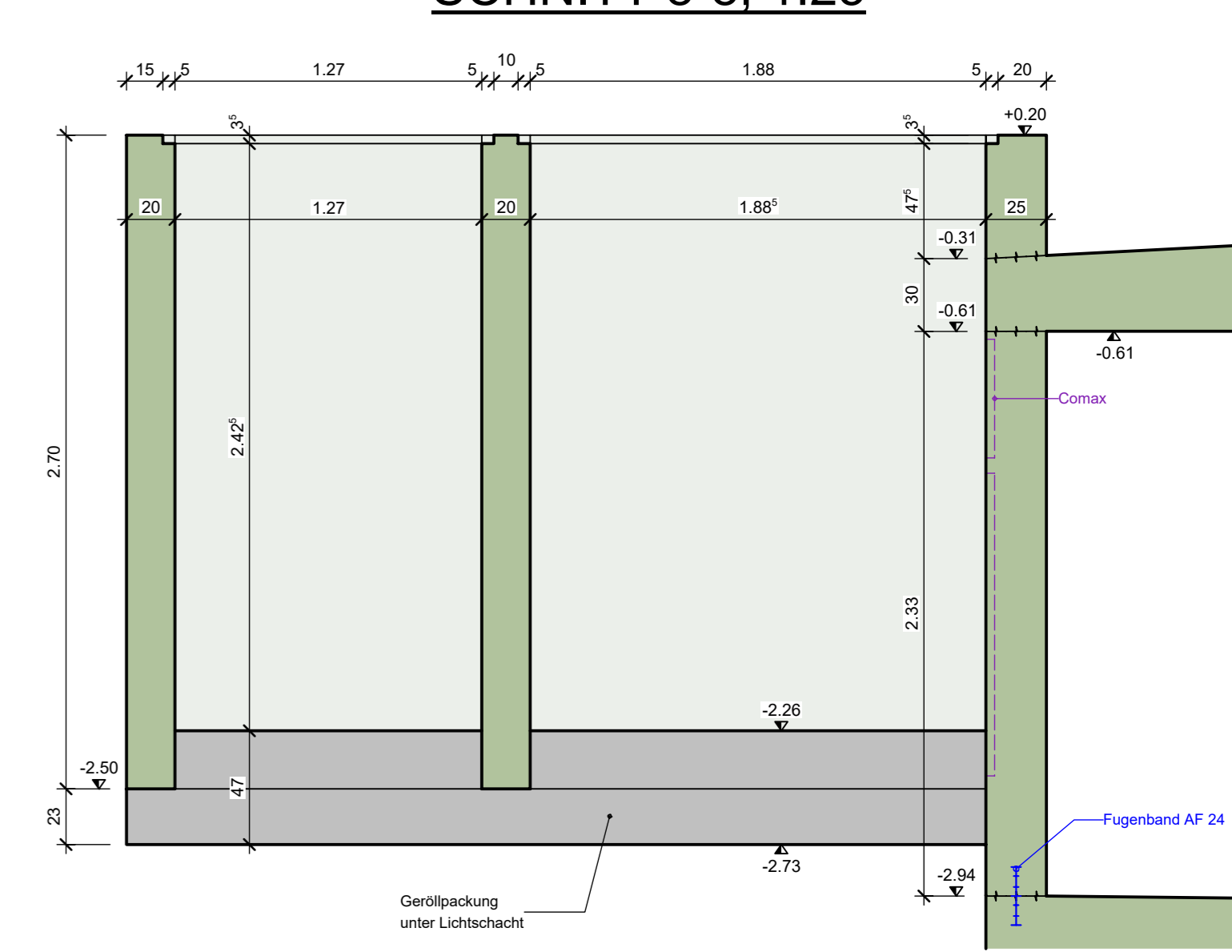

SCHNITT 1-1, 1:50

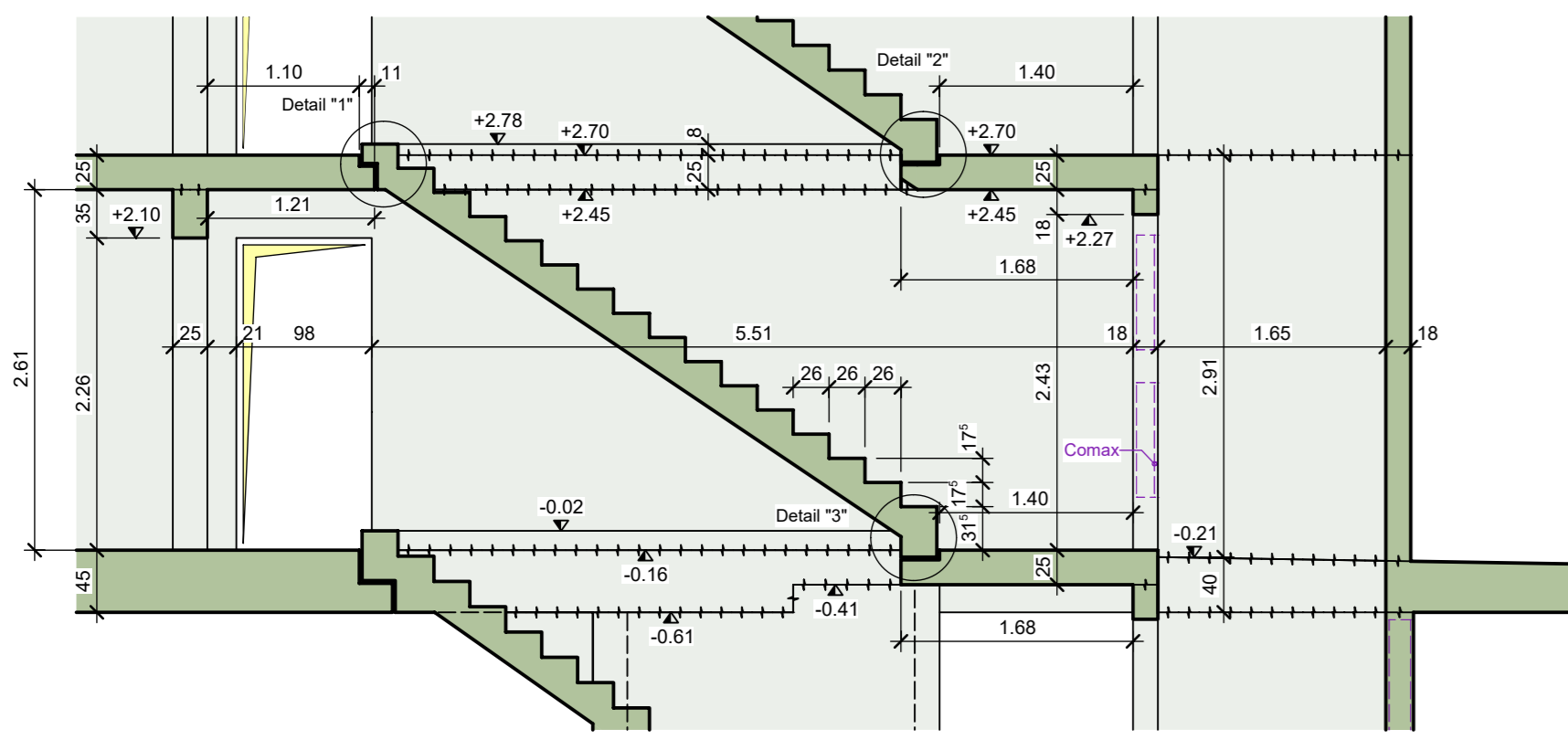

SCHNITT 2-2, 1:50

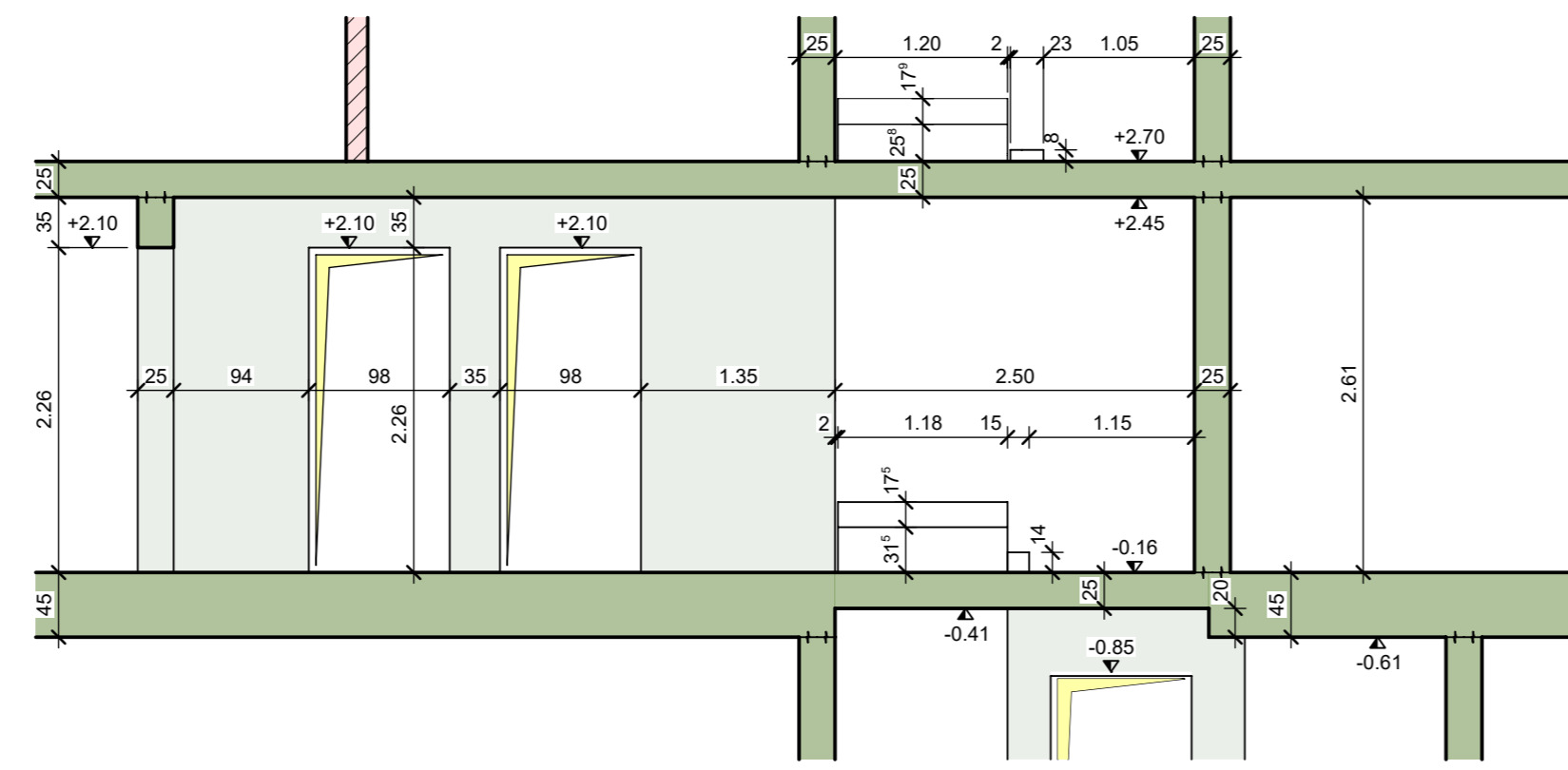

SCHNITT 3-3, 1:50

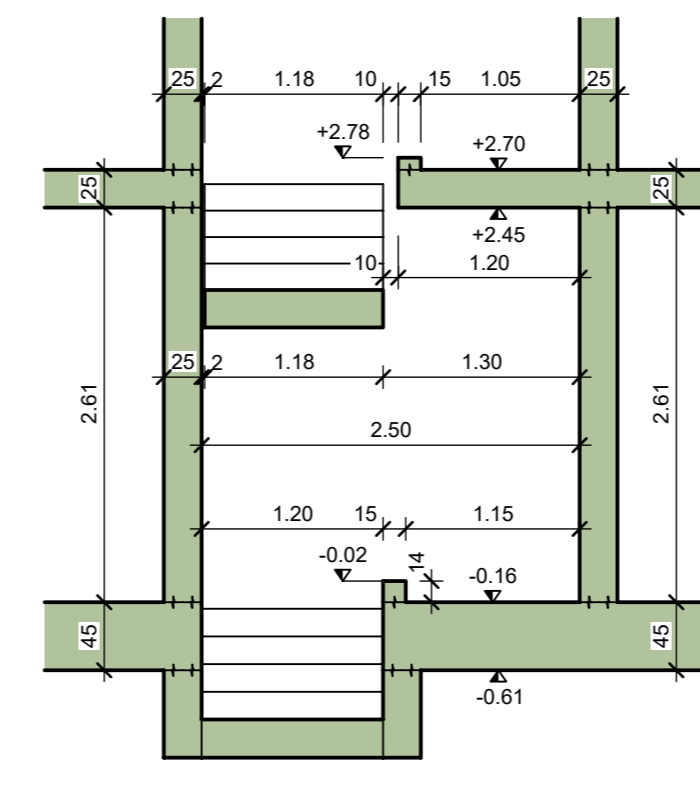

SCHNITT 4-4, 1:50

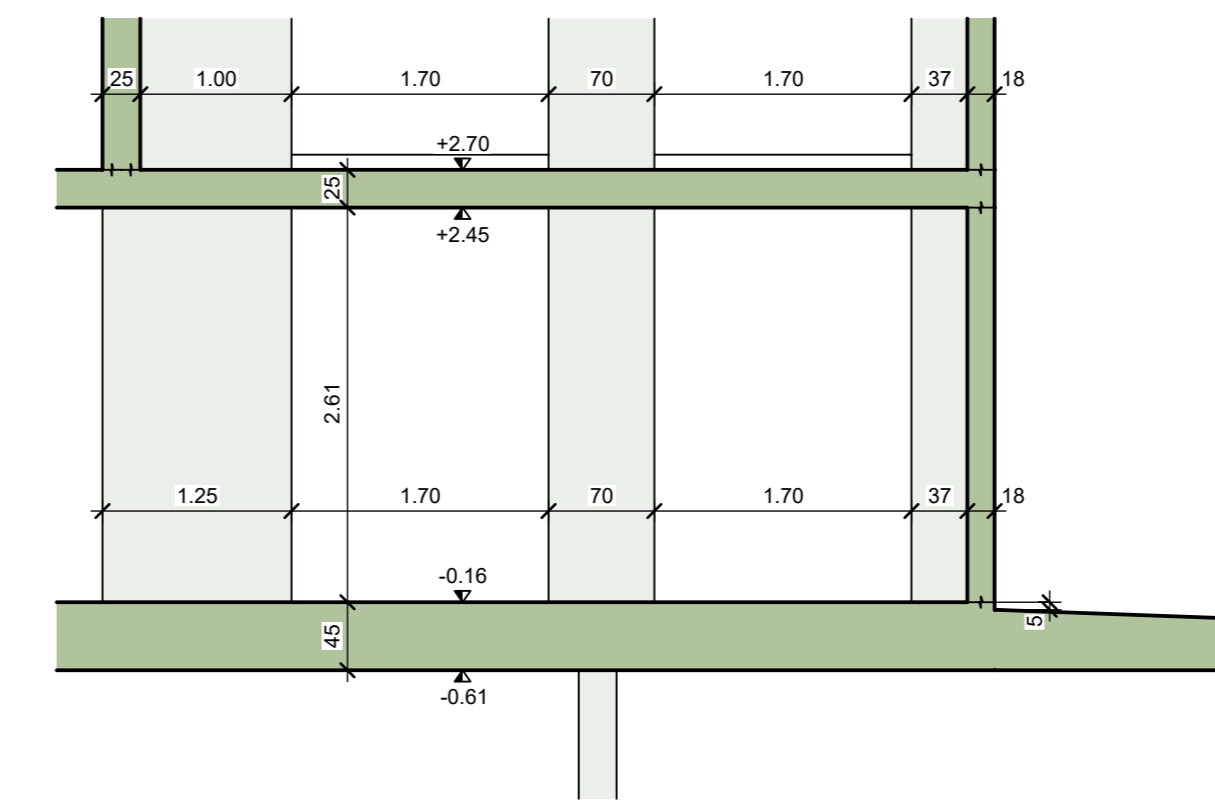

SCHNITT 5-5, 1:50

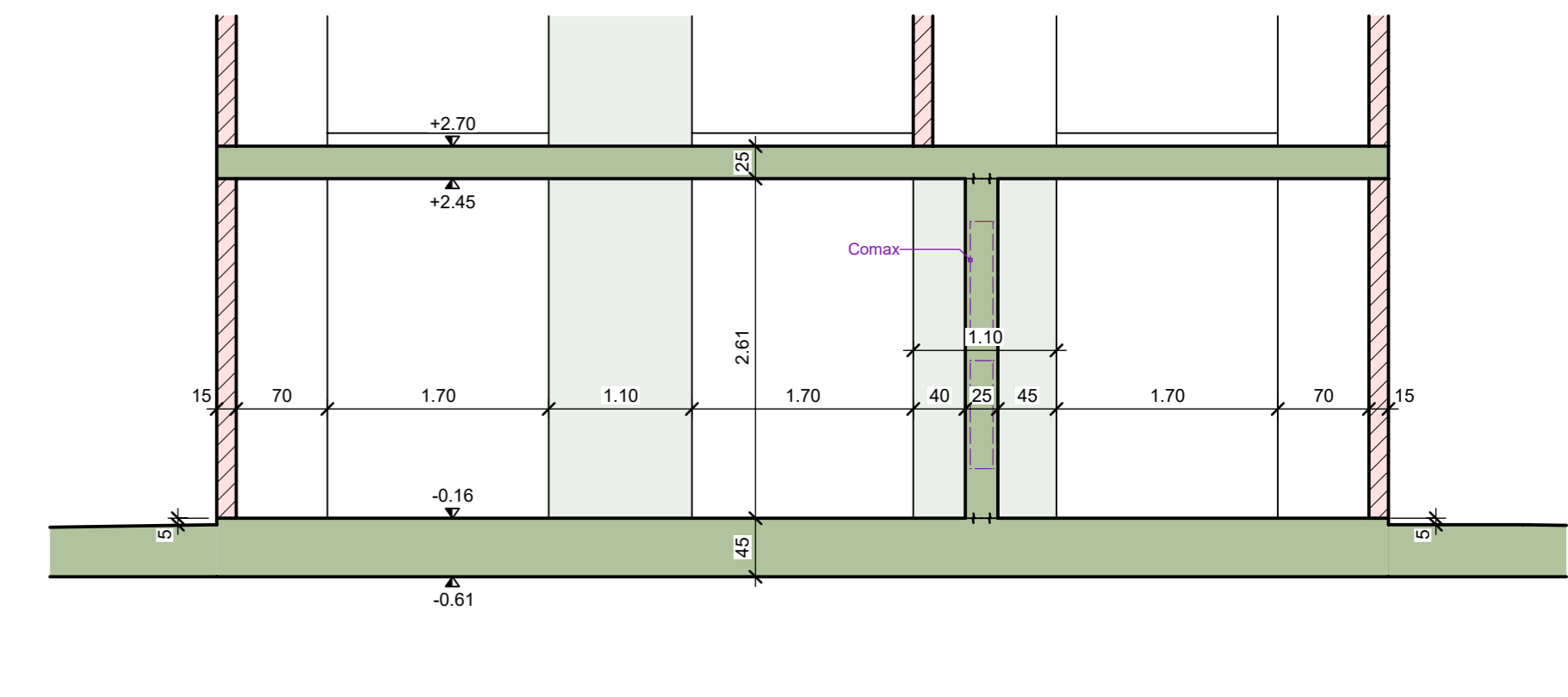

DETAILSCHNITT A-A, 1:20

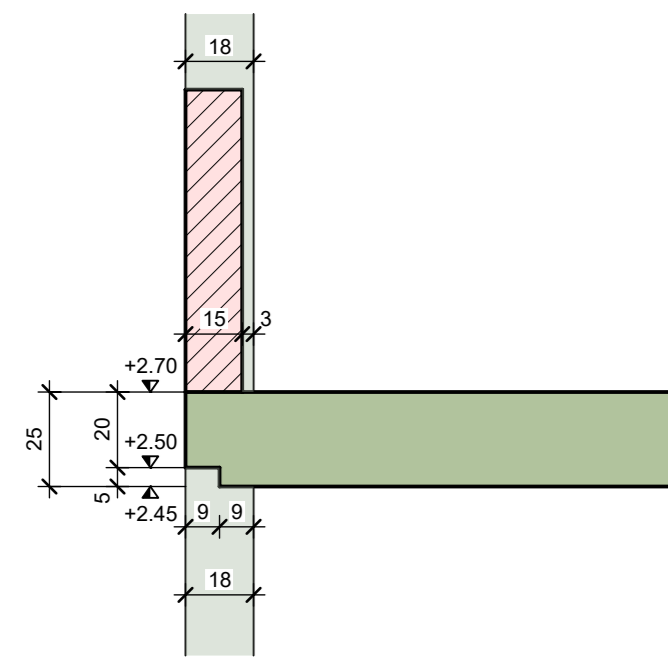

DETAILSCHNITT B-B, 1:20

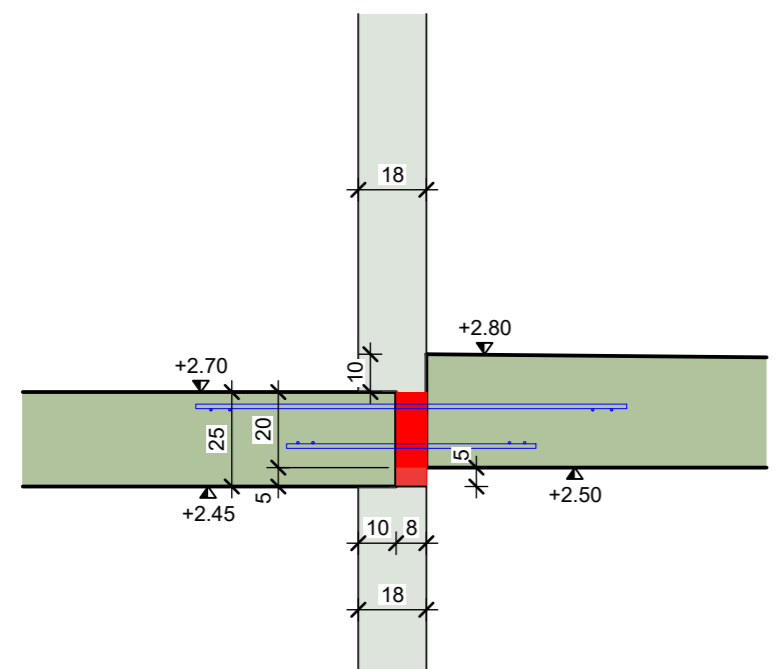

DETAILSCHNITT C-C, 1:20

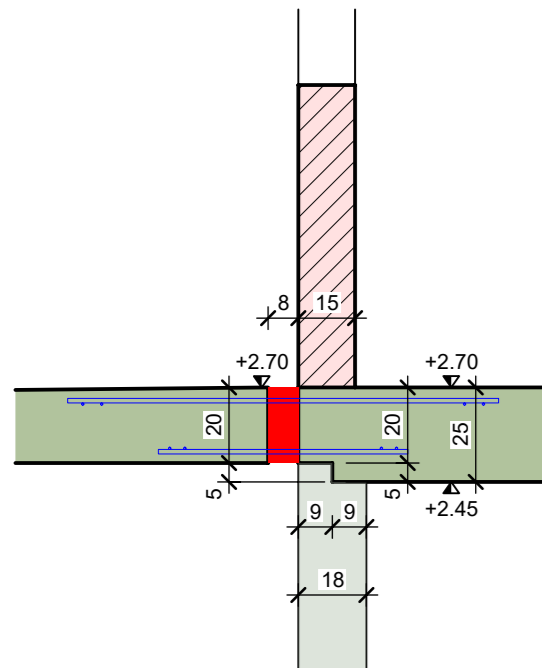

DETAIL "1", 1:20

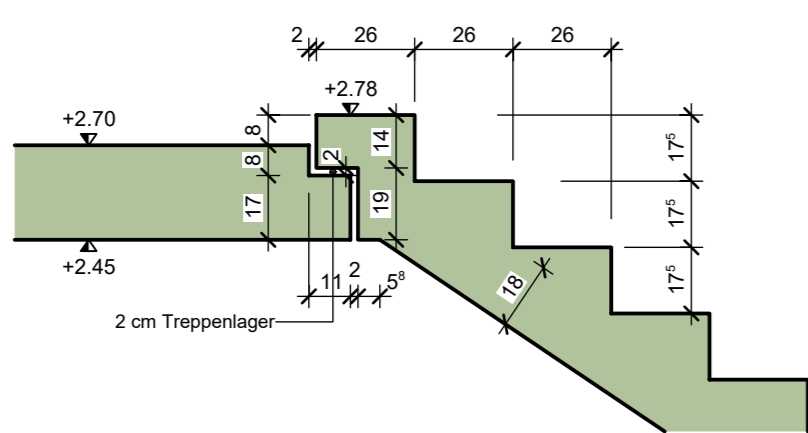

DETAIL "2", 1:20

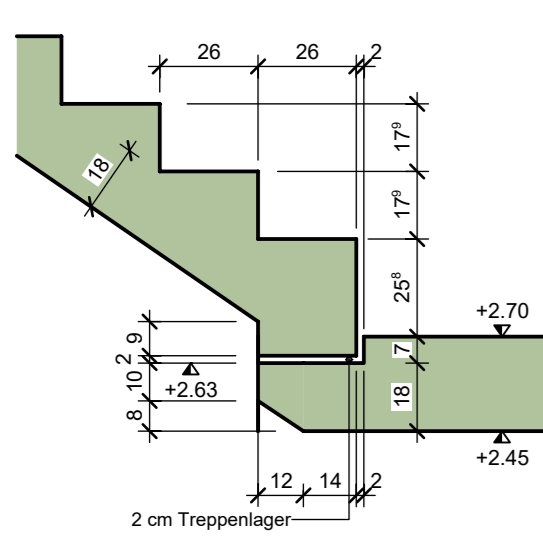

DETAIL "3", 1:20

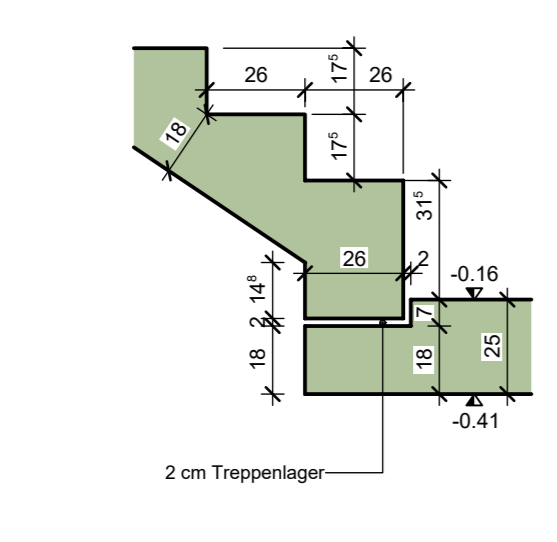

GRUNDRIS, 1:50

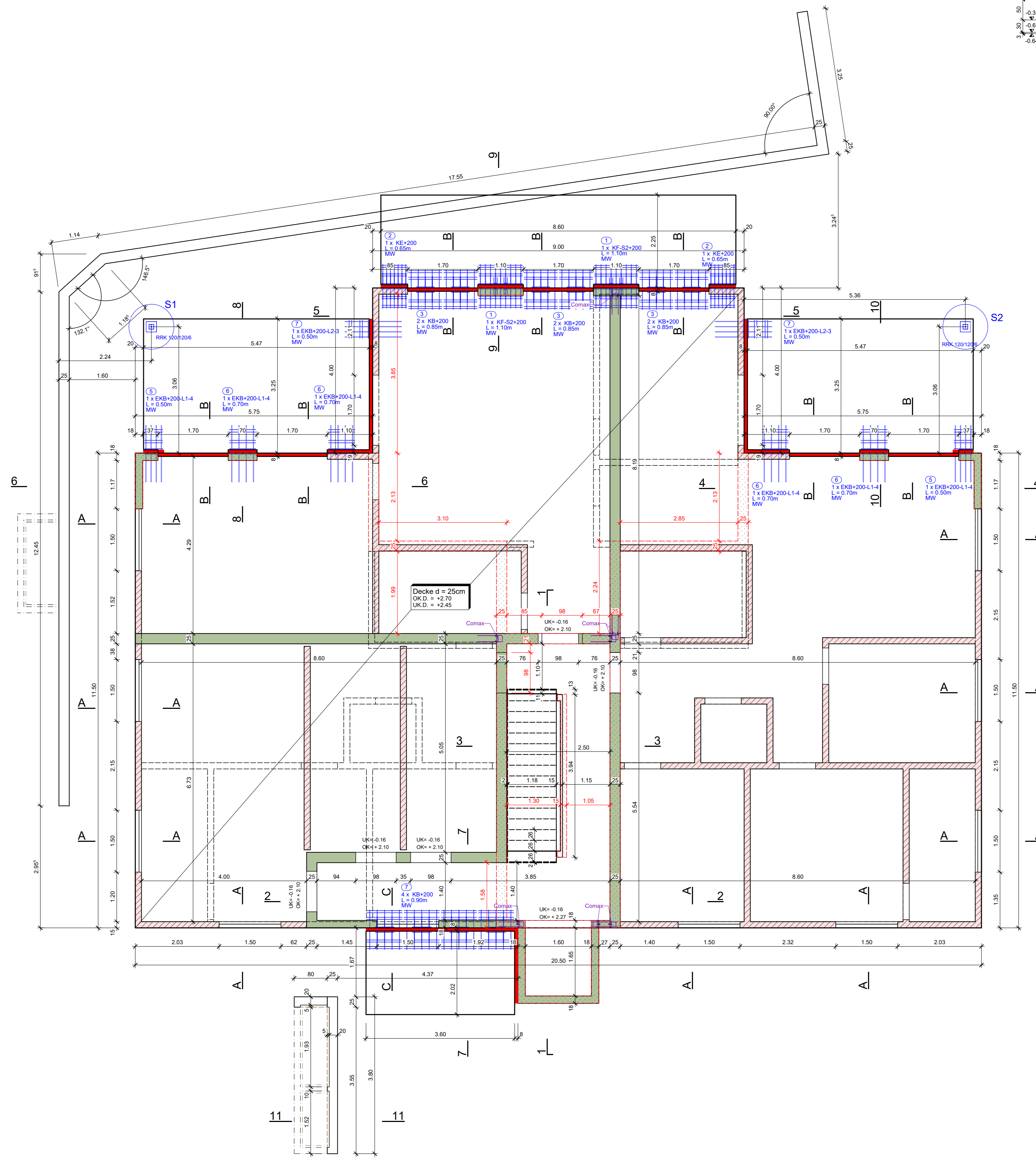

SCHNITT 6-6, 1:50

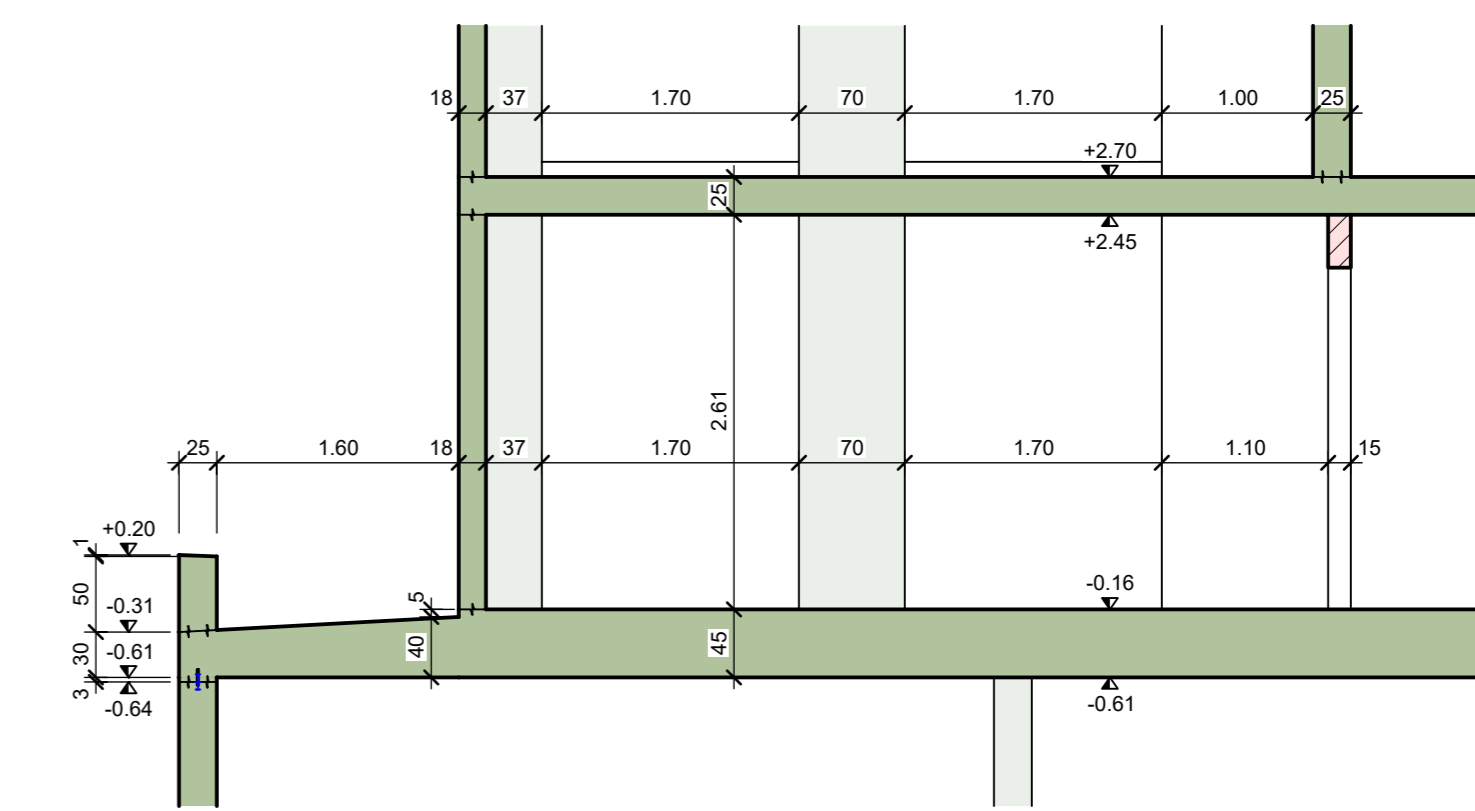

SCHNITT 7-7, 1:50

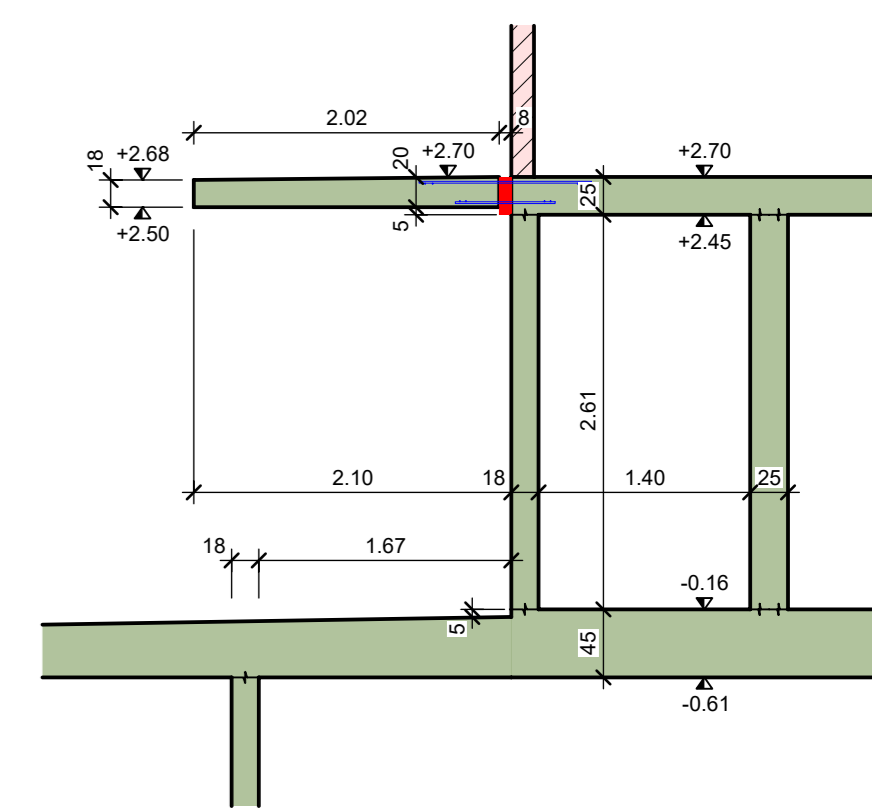

SCHNITT 8-8, 1:50

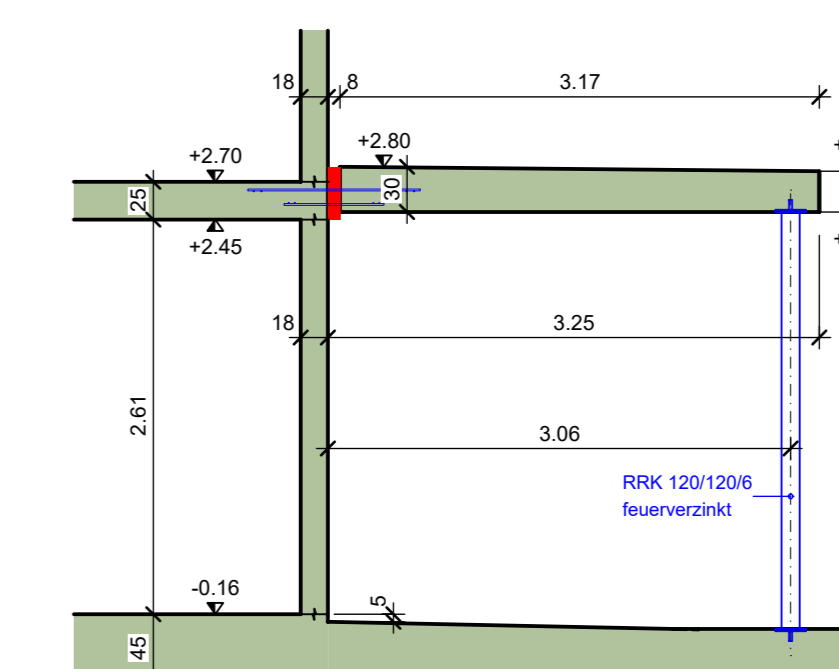

SCHNITT 9-9, 1:50

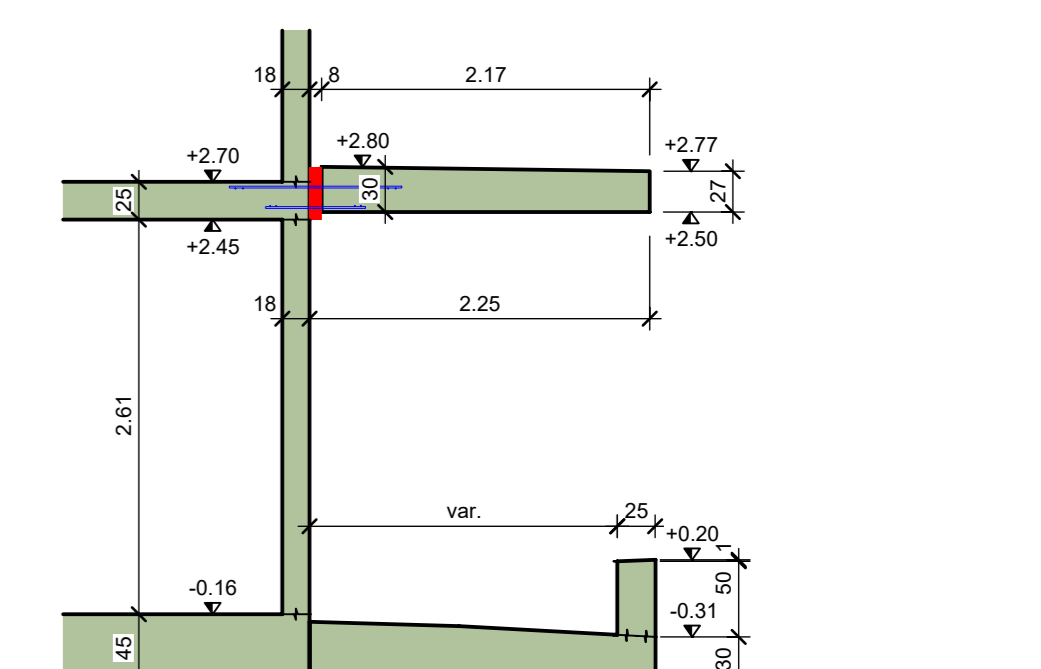

SCHNITT 10-10, 1:50

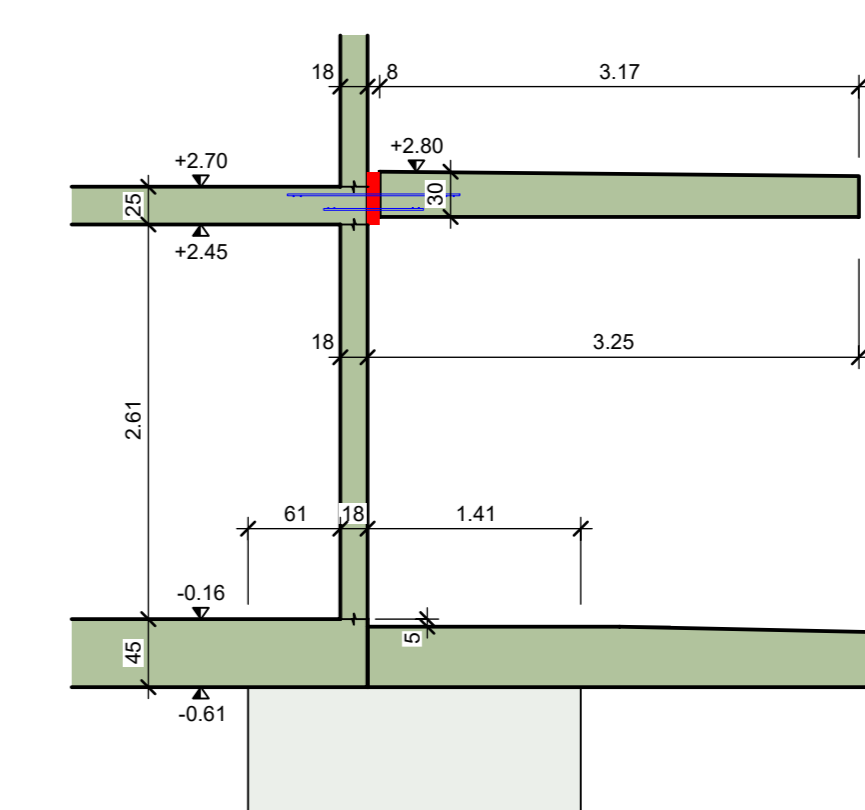

SCHNITT 11-11, 1:20

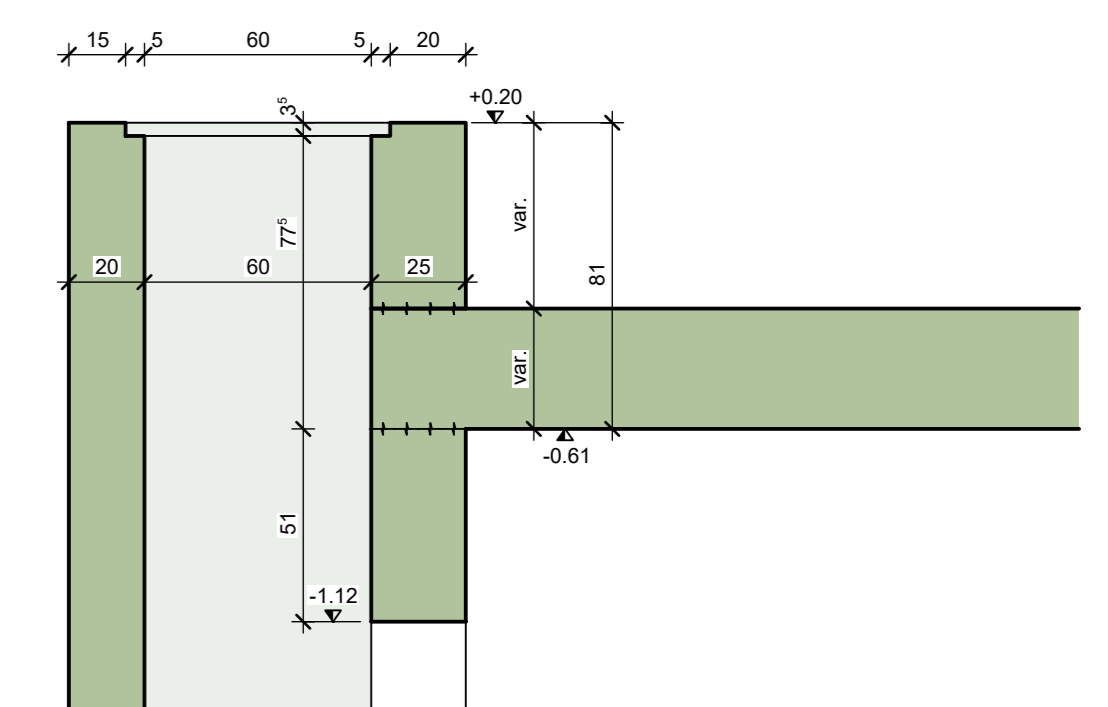

DETAIL STAHLSTÜTZE-S1, 1:20

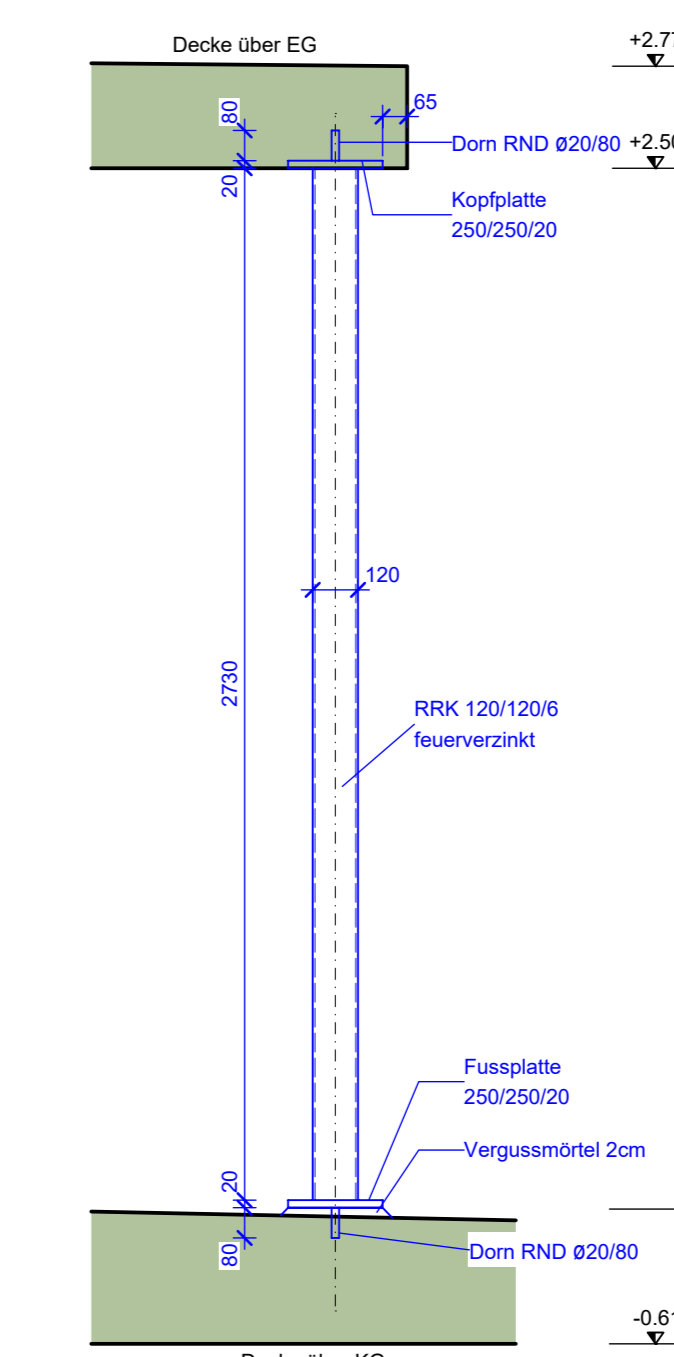

DETAIL STAHLSTÜTZE-S2, 1:20

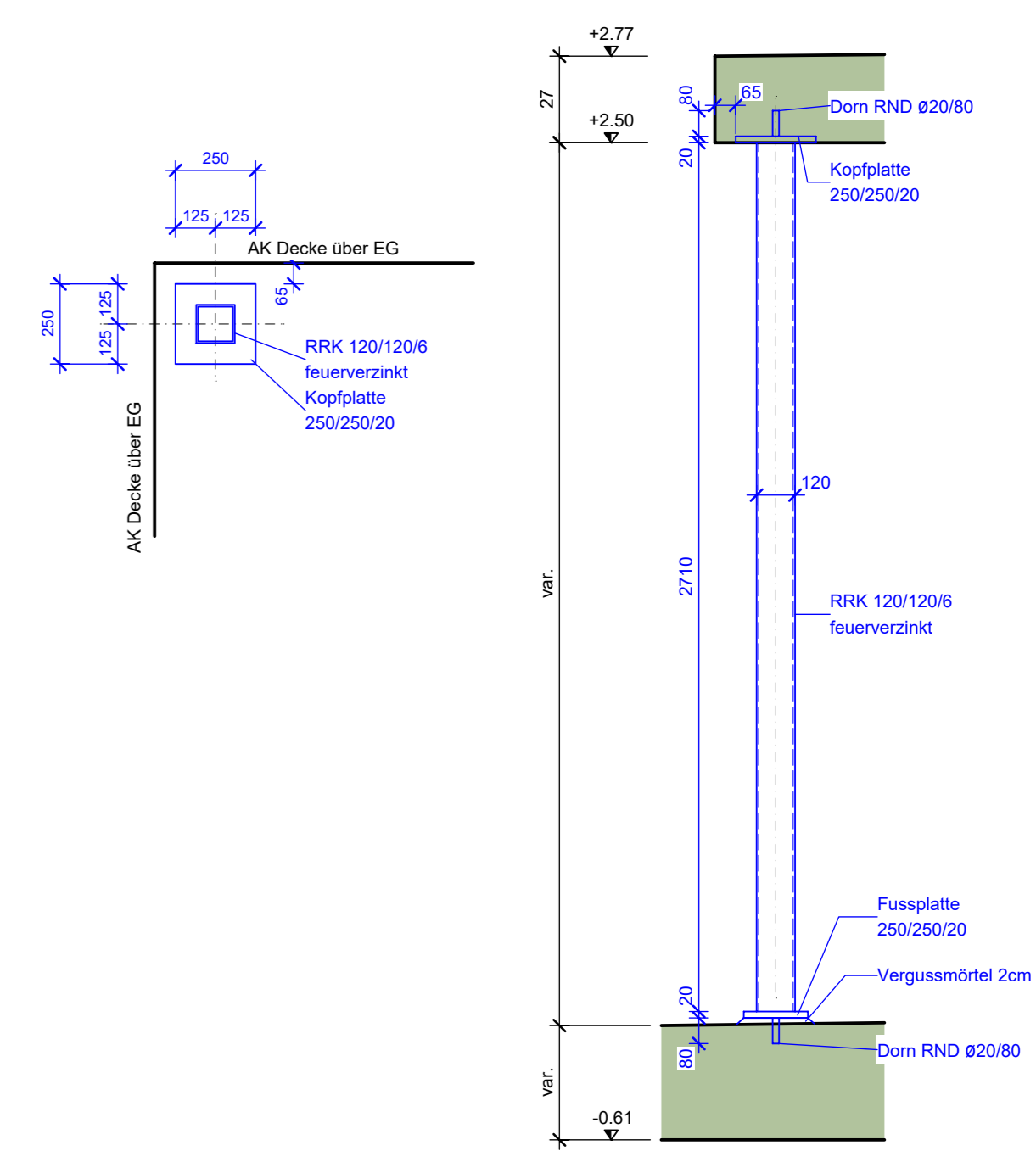

DETAIL 1, 1:25

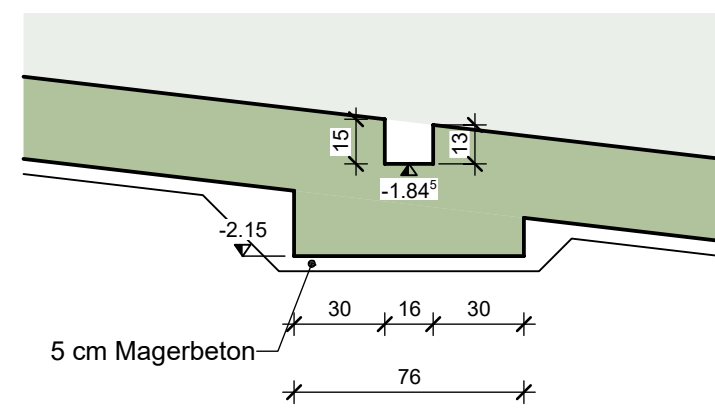

DETAIL 2, 1:25

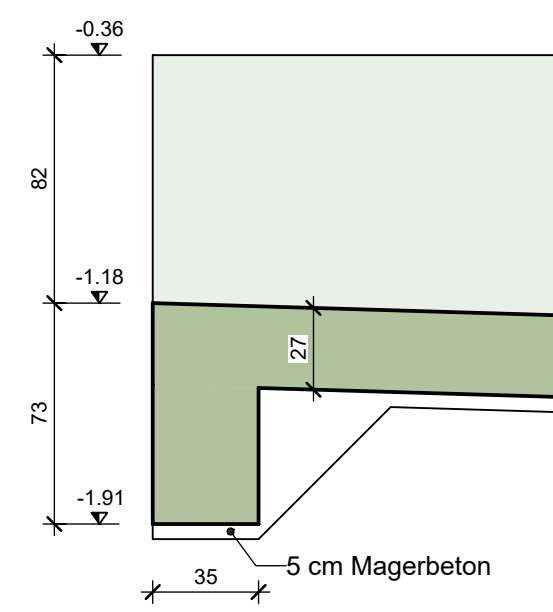

SCHNITT 1-1, 1:50

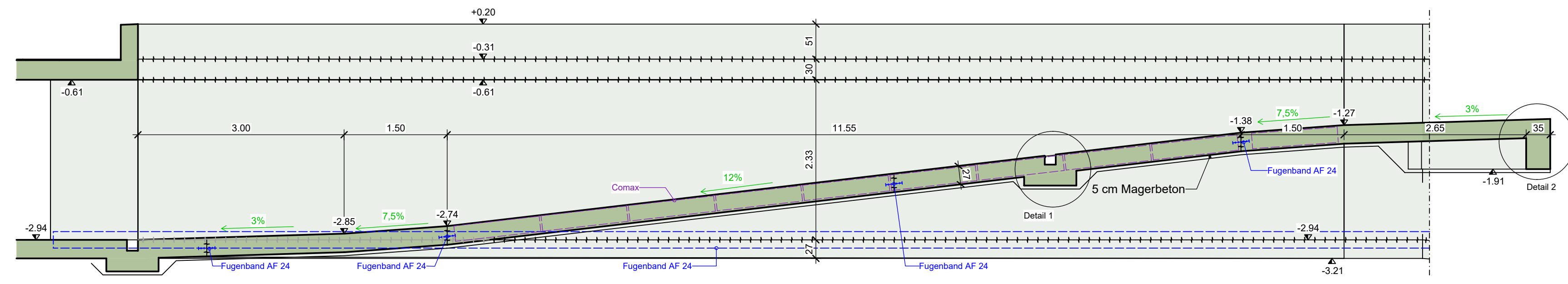

SCHNITT 3-3, 1:50

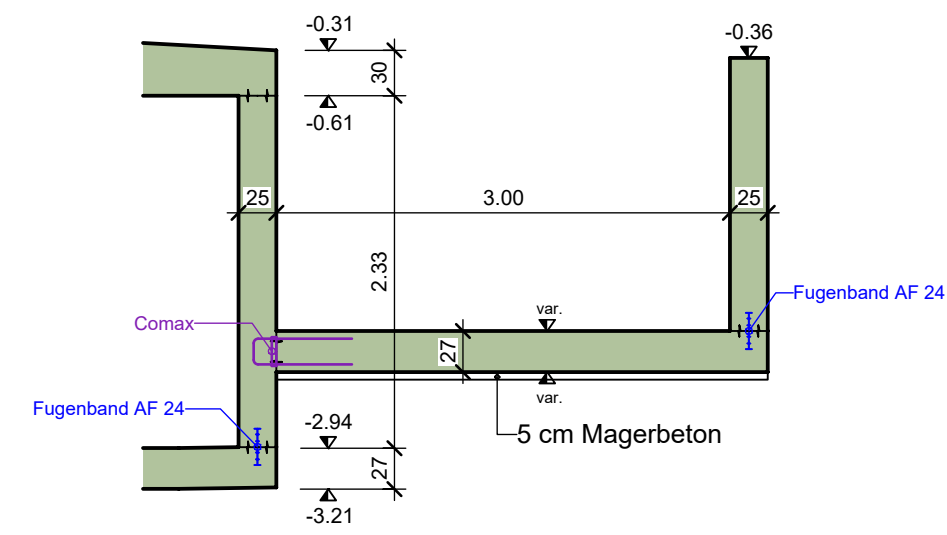

SCHNITT 2-2, 1:50

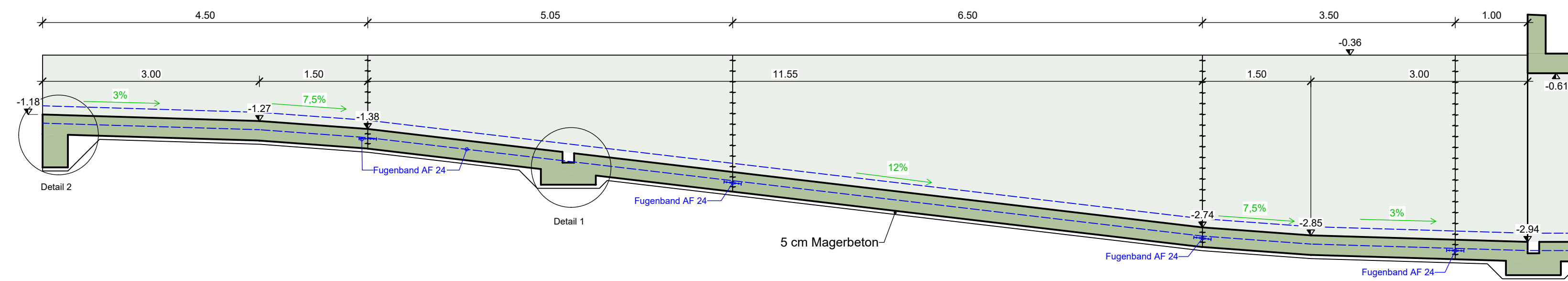

GRUNDRISS, 1:50

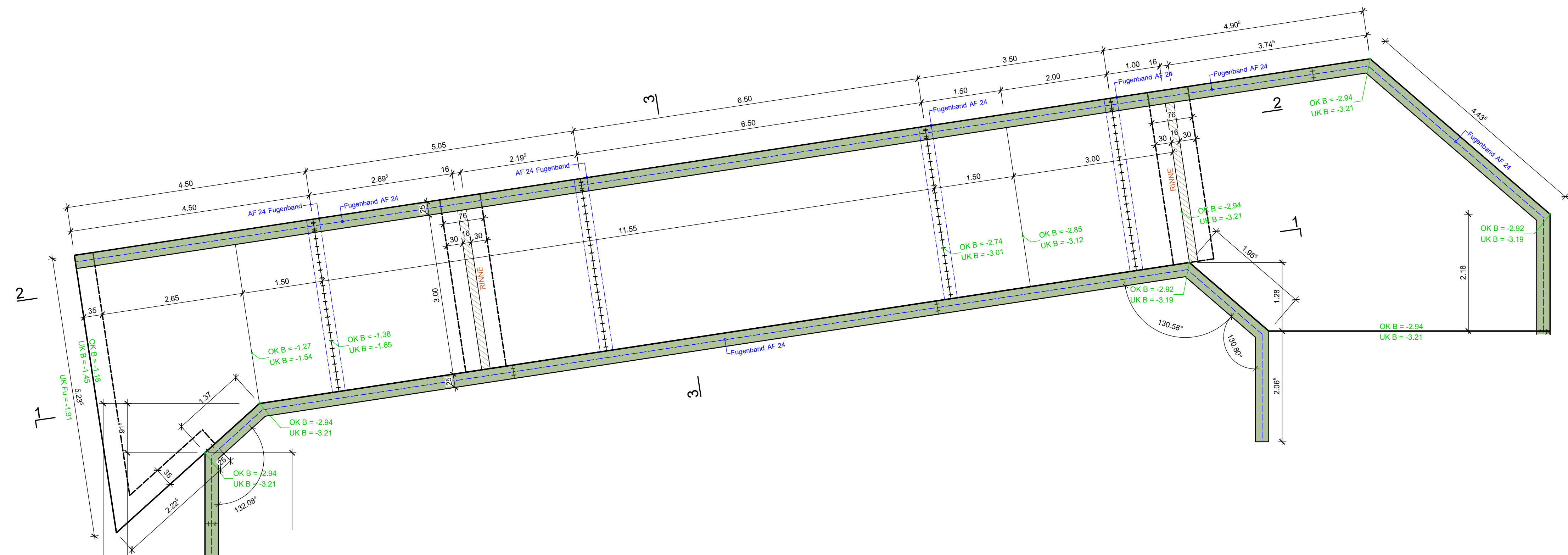

SCHNITT 1-1, 1:50

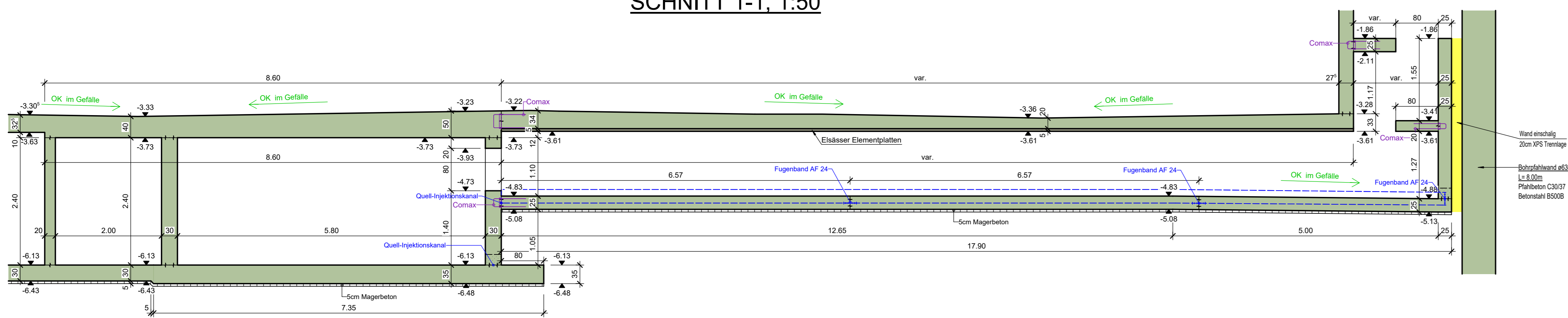

GRUNDRISS, 1:50
Bodenplatte

- Bodenplatte d = 35cm
OK.D. = -6.13
UK.B. = -6.48
- Bodenplatte d = 30cm
OK.D. = -6.13
UK.B. = -6.43
- Bodenplatte Lüfterfahrt d = 30cm
OK.D. = -7.18
UK.D. = -7.48

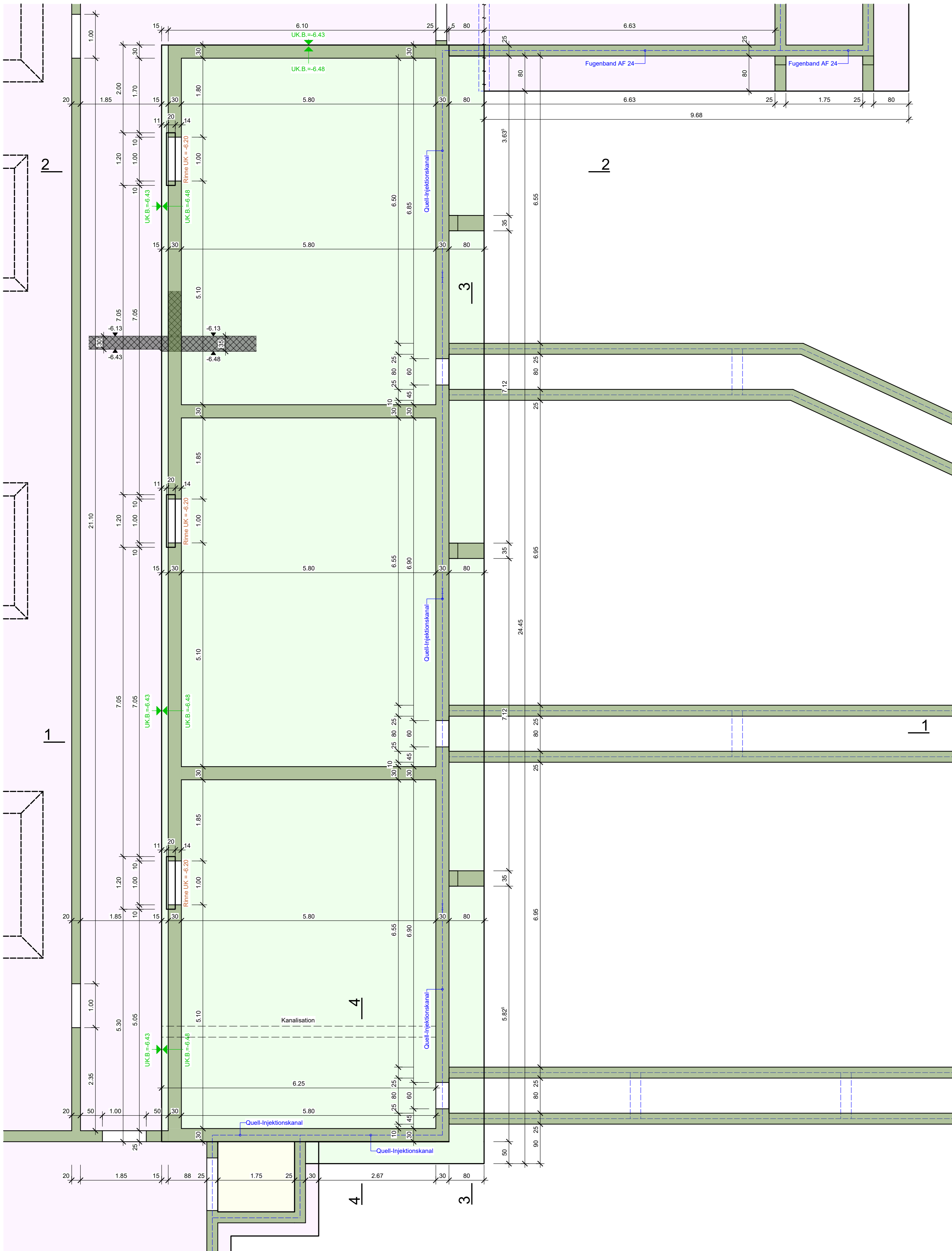

SCHNITT 2-2, 1:50

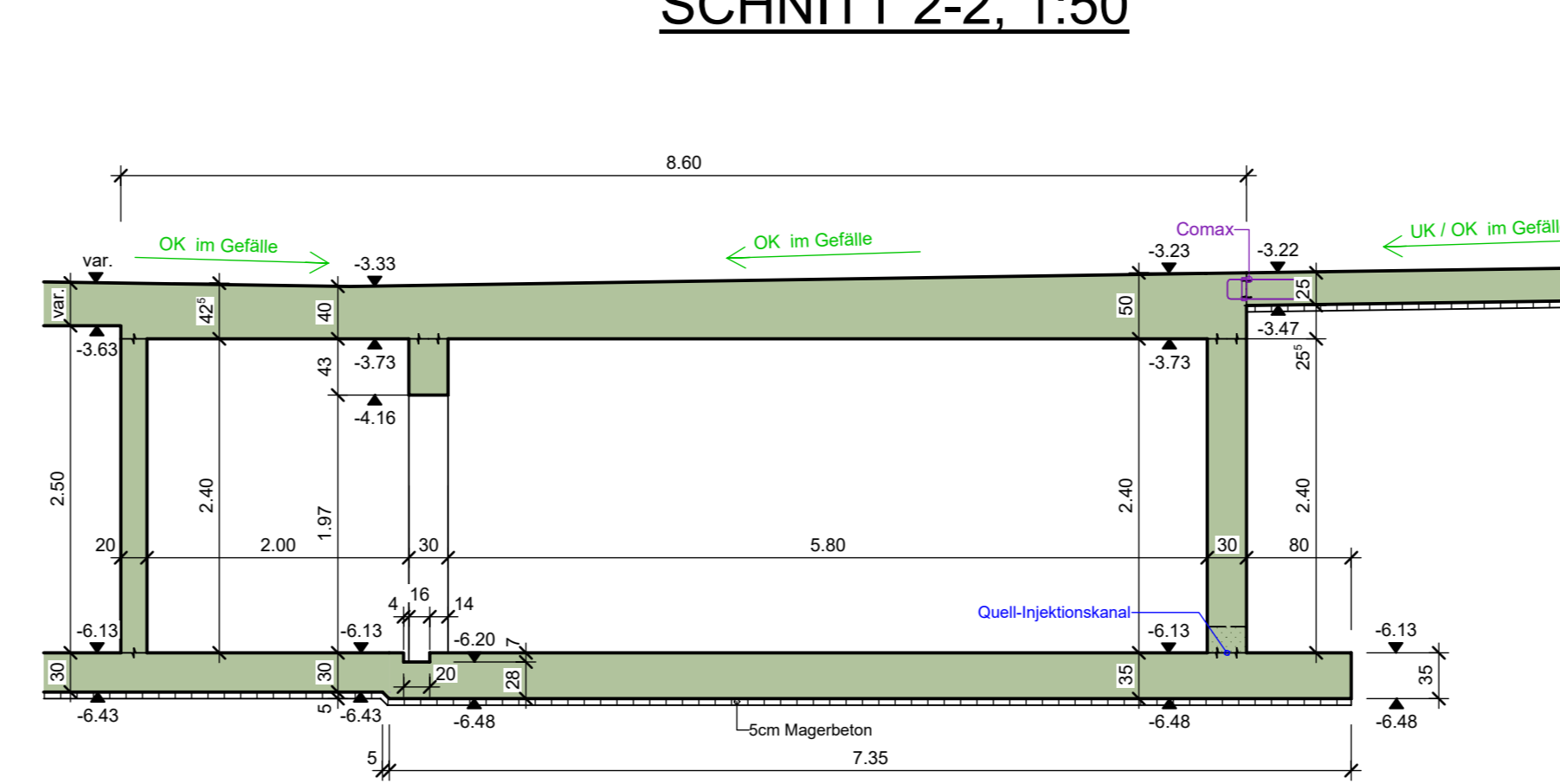

GRUNDRISS, 1:50
Wände+Decke

- Decke d = 40-50cm
OK.D. = var.
UK.D. = -3.73
- Decke d = 30-45cm
OK.D. = var.
UK.D. = -3.63
- Decke d = 30cm
OK.D. = -3.23
UK.D. = -3.53
- Notausstieg
OK.D. = var.
UK.D. = -3.61
- Bodenplatte d = 25cm
OK.D. = var.
UK.D. = var.

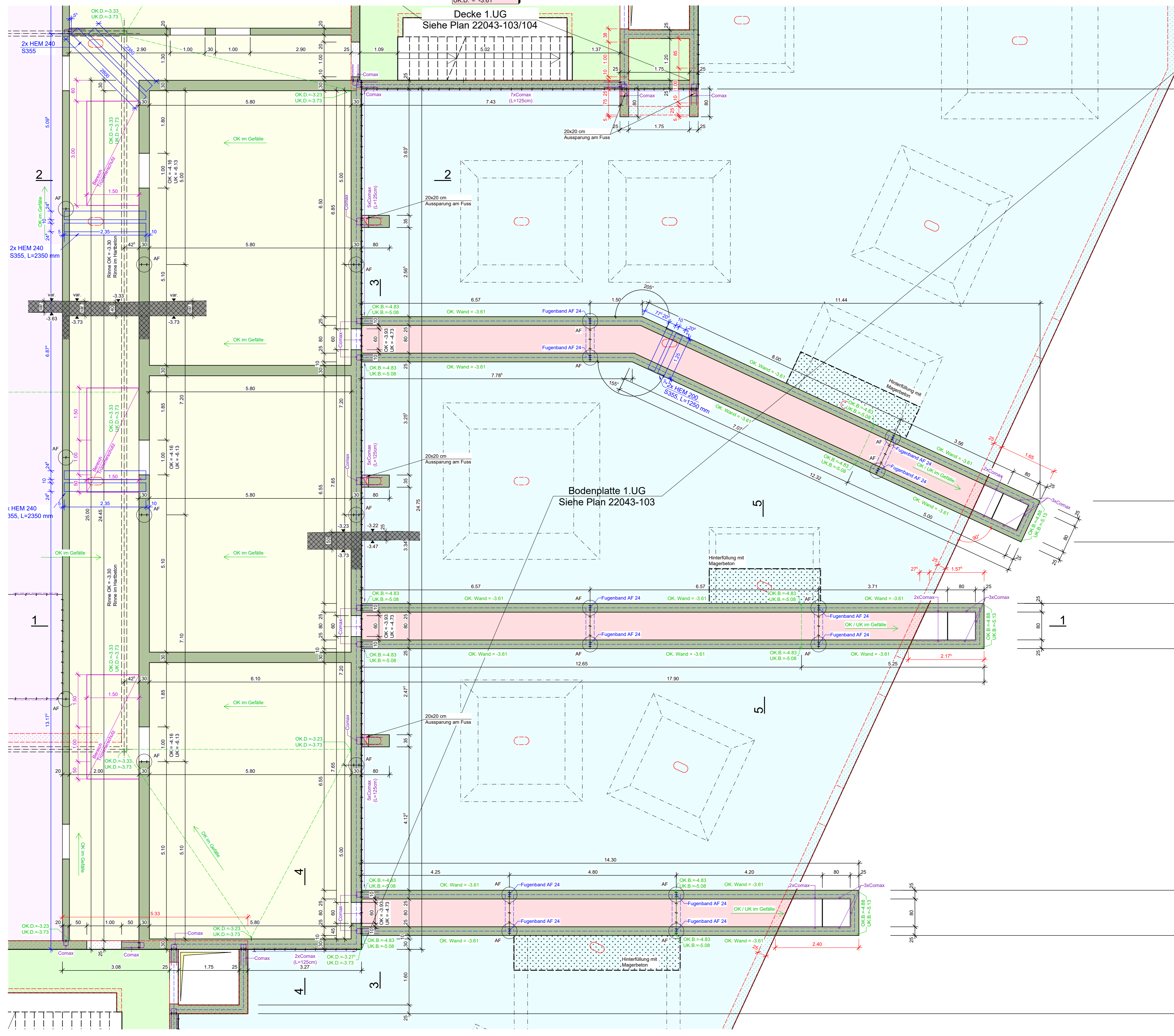

SCHNITT 3-3, 1:50

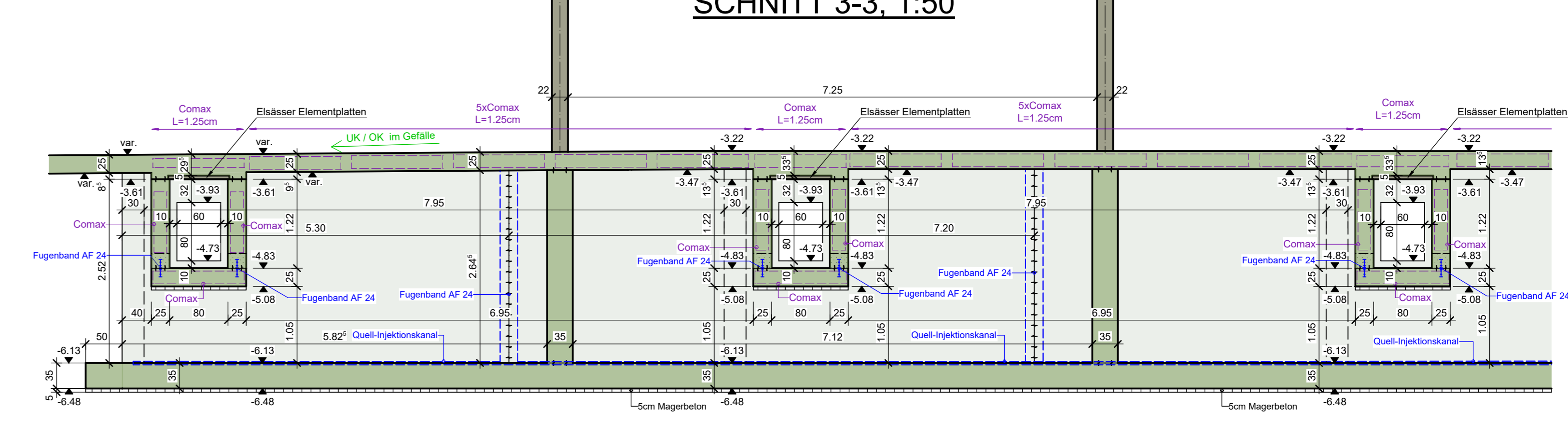

SCHNITT 4-4, 1:50

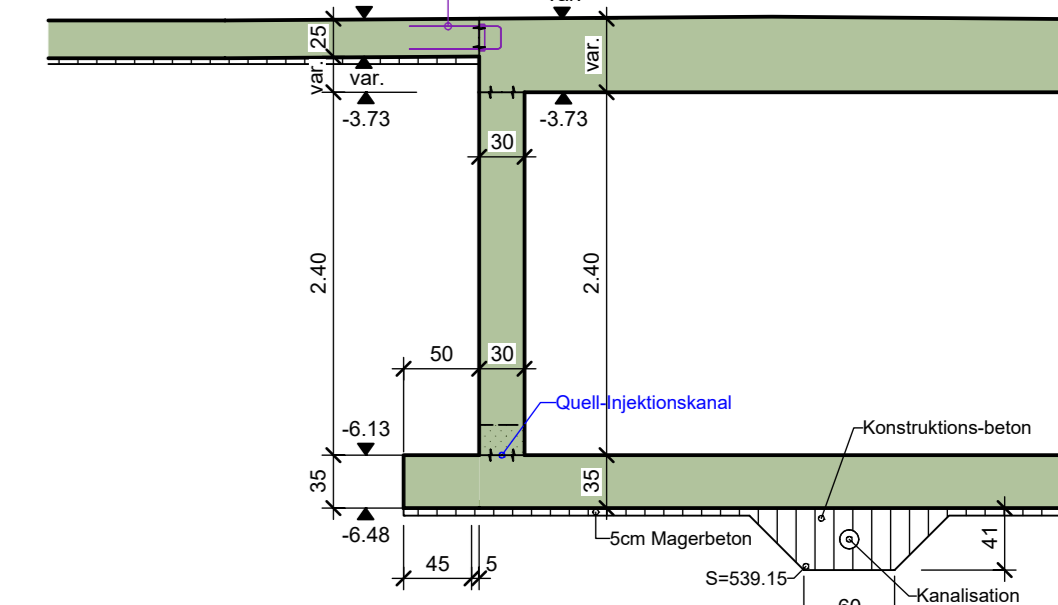

SCHNITT 5-5, 1:50

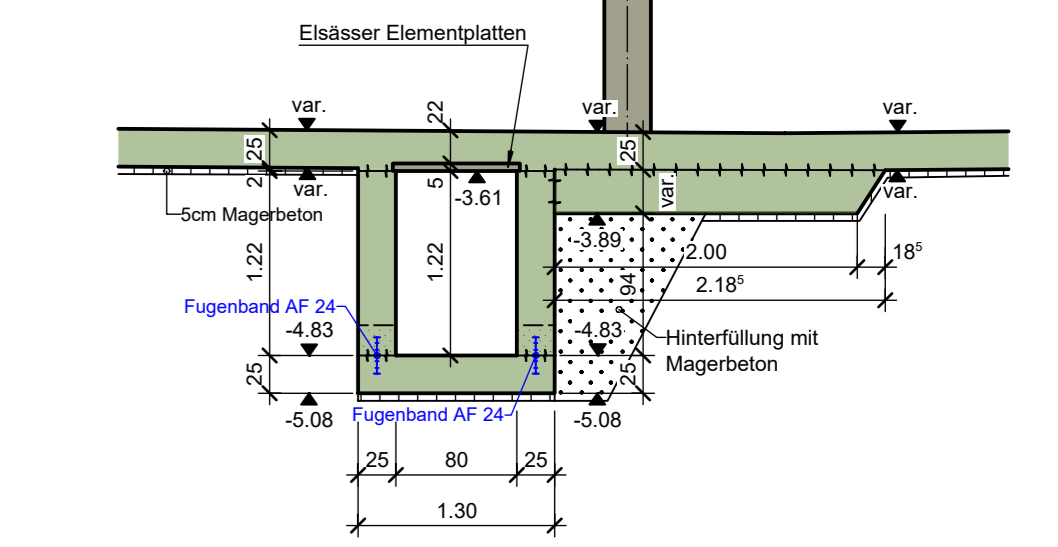

DETAIL, 1:20
Elementplatten

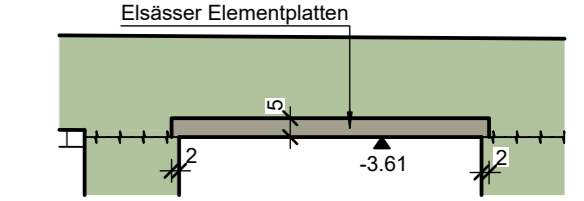

GRUNDRISS, 1:50
Bodenplatte

Bodenplatte d = 30cm
OK.B. = -6.13
UK.B. = -6.43

Bodenplatte
Liftunterfahrt d = 30cm
OK.D. = -7.18
UK.D. = -7.48

Bodenplatte d = 35cm
OK.B. = -6.13
UK.B. = -6.48

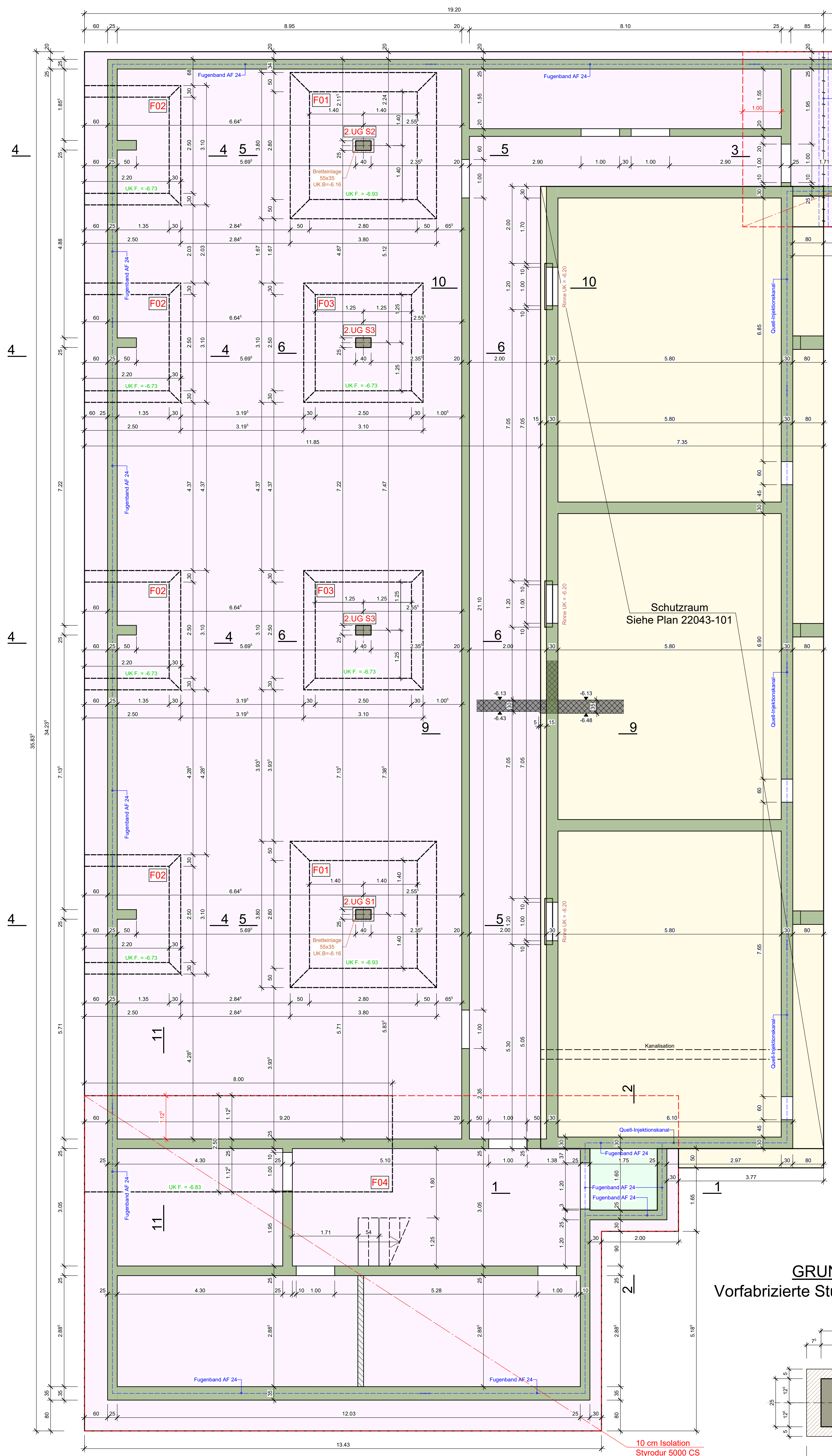

SCHNITT 1-1, 1:50

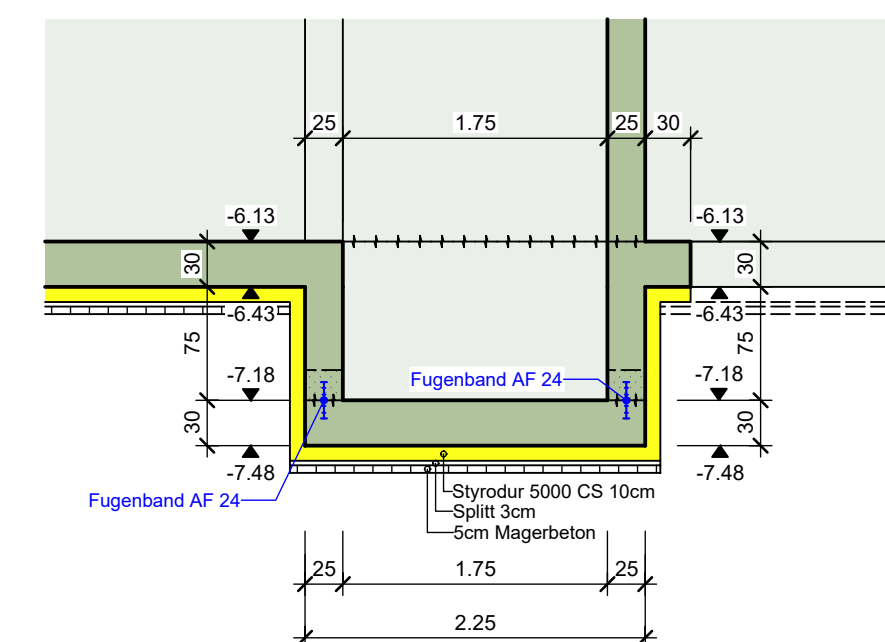

SCHNITT 2-2, 1:50

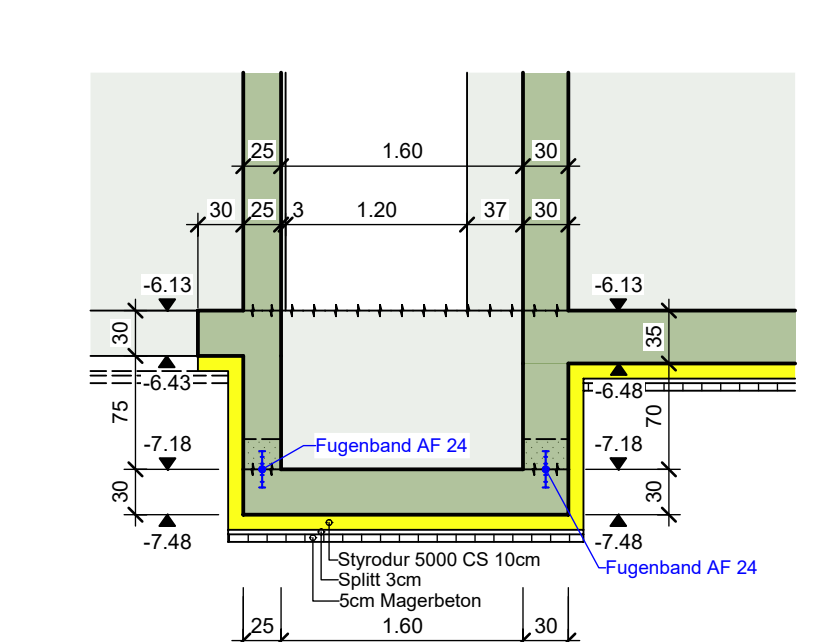

SCHNITT 3-3, 1:50

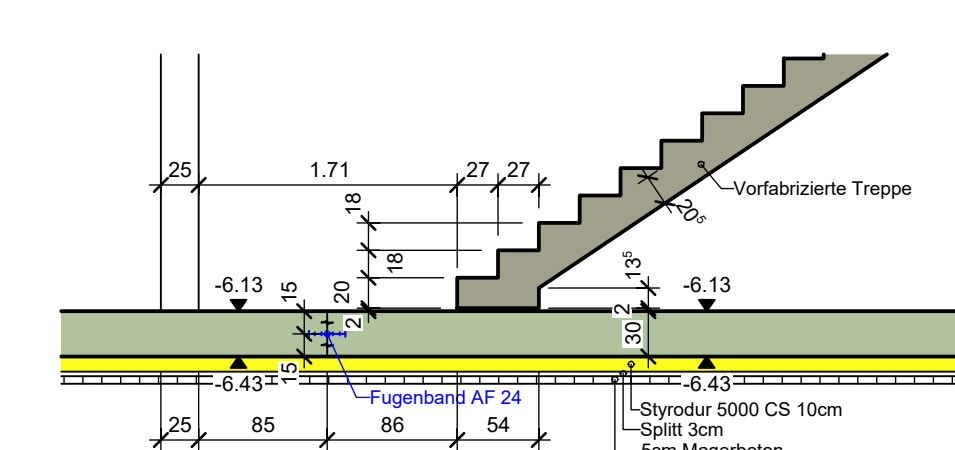

SCHNITT 4-4, 1:50

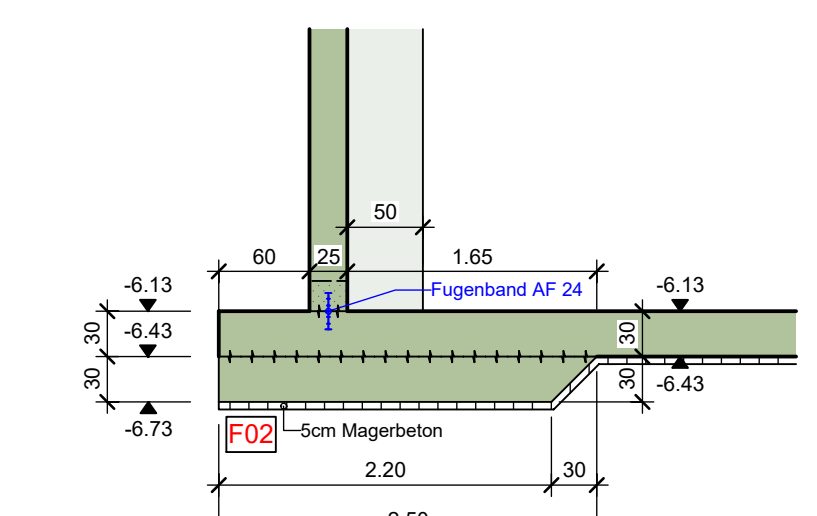

SCHNITT 5-5, 1:50

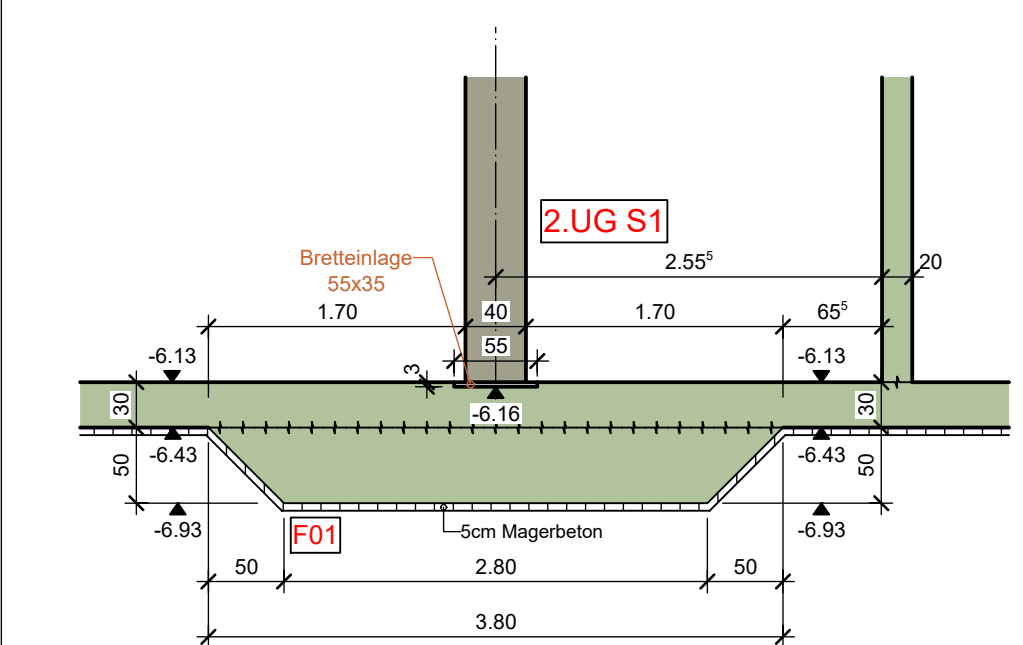

SCHNITT 6-6, 1:50

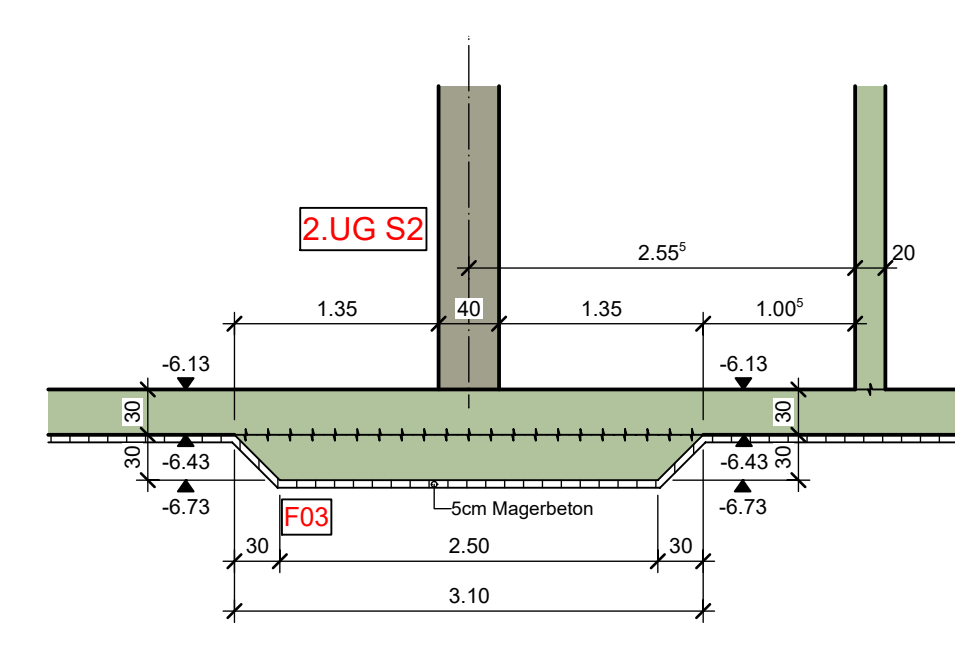

SCHNITT 7-7, 1:50

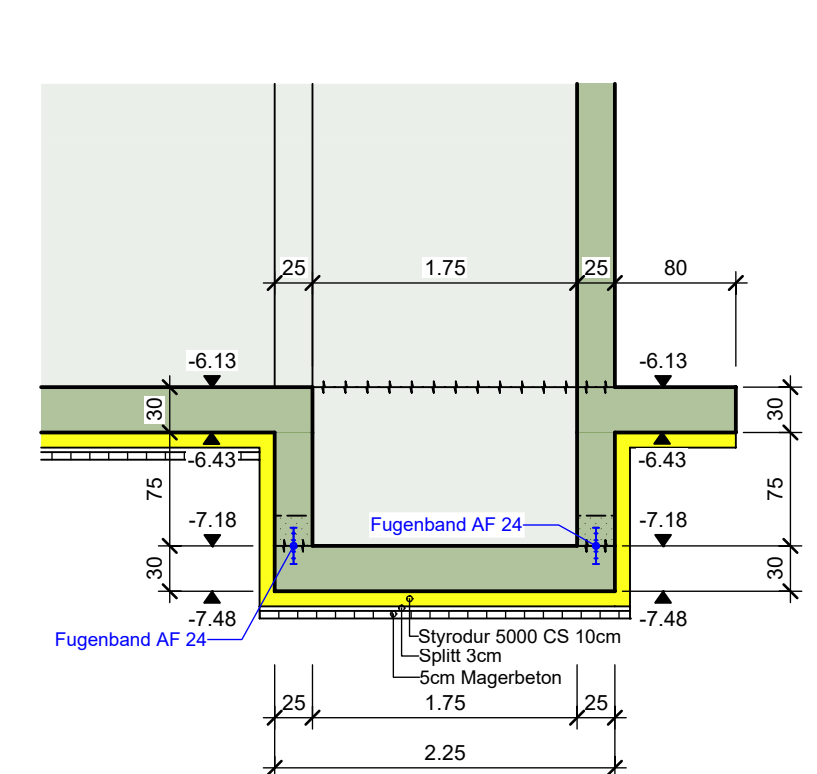

SCHNITT 8-8, 1:50

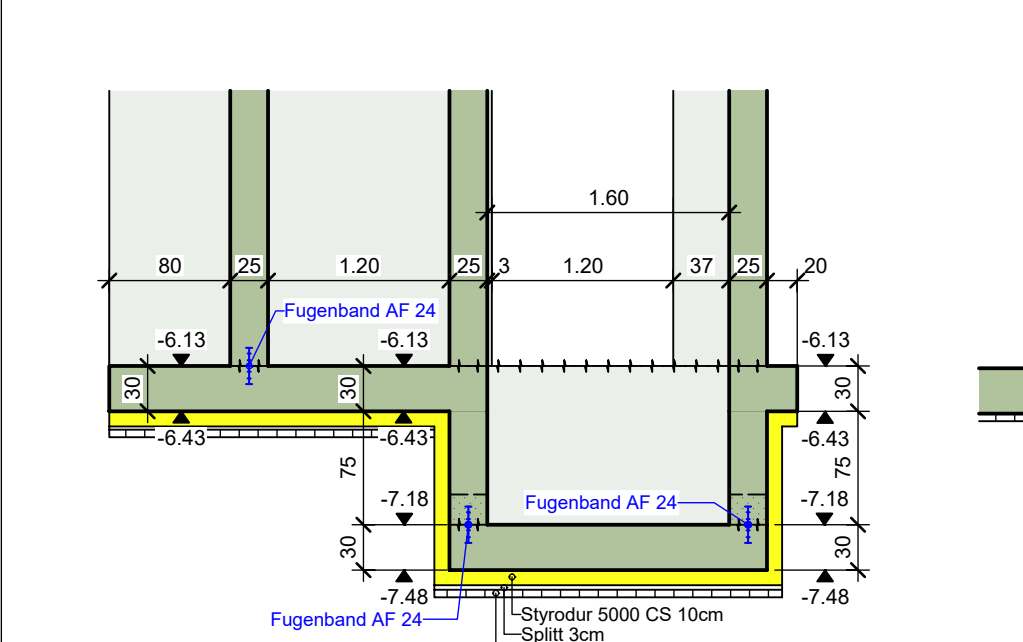

SCHNITT 9-9, 1:50

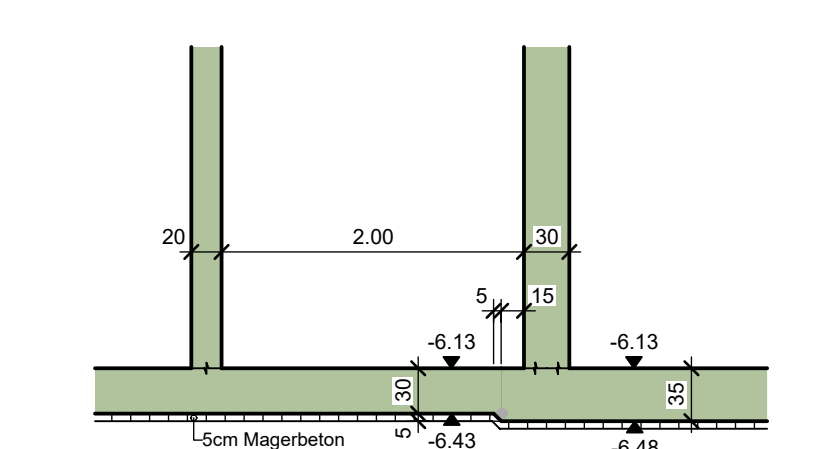

SCHNITT 10-10, 1:50

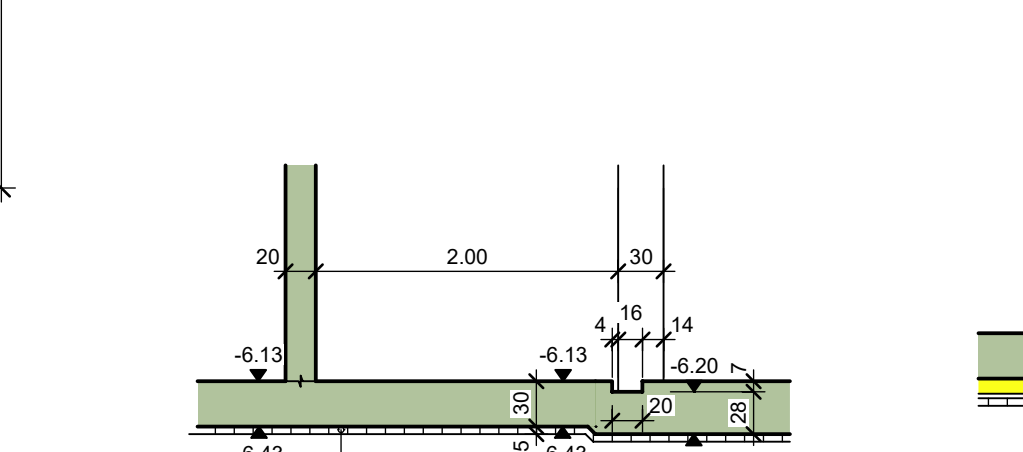

SCHNITT 11-11, 1:50

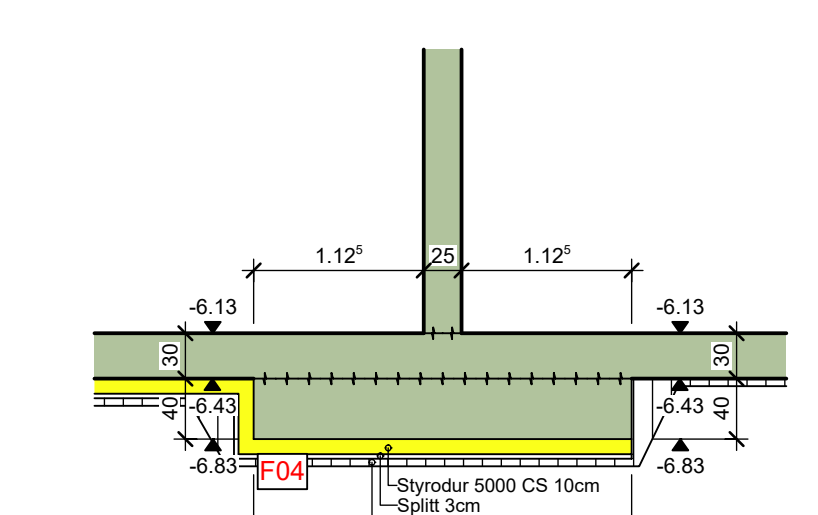

GRUNDRISS, 1:10
Vorfabrizierte Stütze 2.UG, S1+2.UG, S2

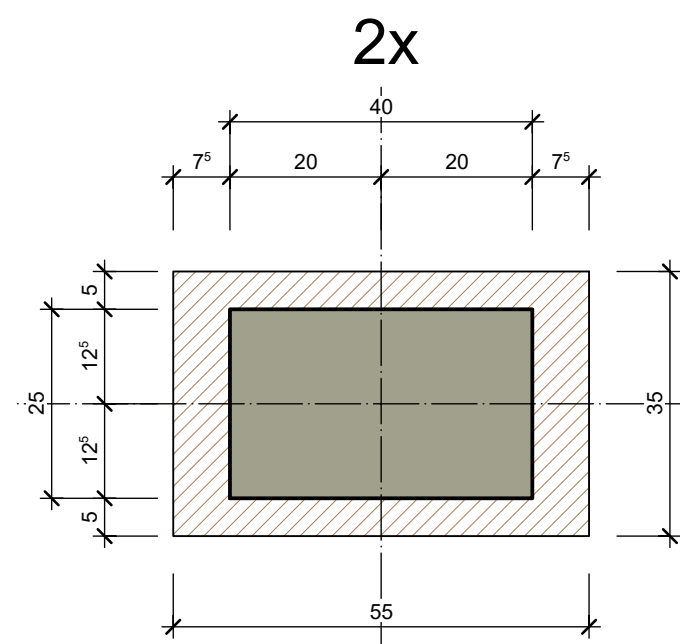

STÜTZE 2.UG, S1+2.UG, S2
FUSSDETAIL 1:20

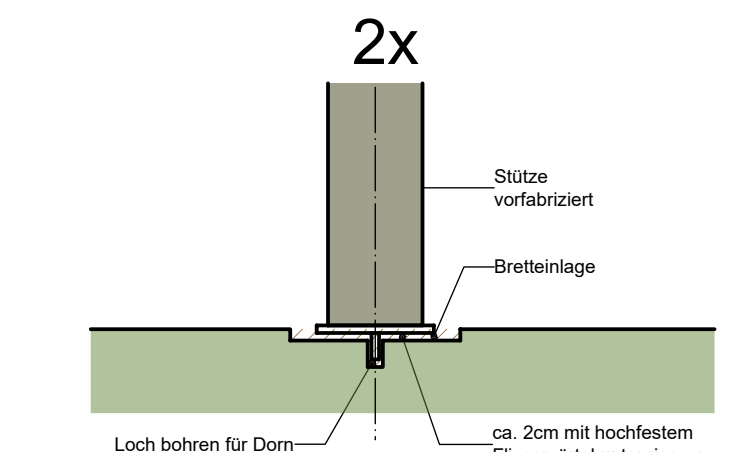

10 cm Isolation
Styrodur 5000 CS
Flommate 700

GRUNDRISS, 1:50

Decke d = 40-50cm OK.D. = var. UK.D. = -3.73	Decke d = 30-45cm OK.D. = var. UK.D. = -3.69	Decke d = 30cm OK.D. = -3.23 UK.D. = -3.53	Decke d = 28-30cm OK.D. = var. UK.D. = -3.53	Decke d = 25-30cm Notausstieg OK.D. = var. UK.D. = -3.61	Bodenplatte d = 25cm OK.B. = var. UK.B. = var.	Bodenplatte d = 25cm OK.B. = -3.23 UK.B. = -3.48
--	--	--	--	---	--	--

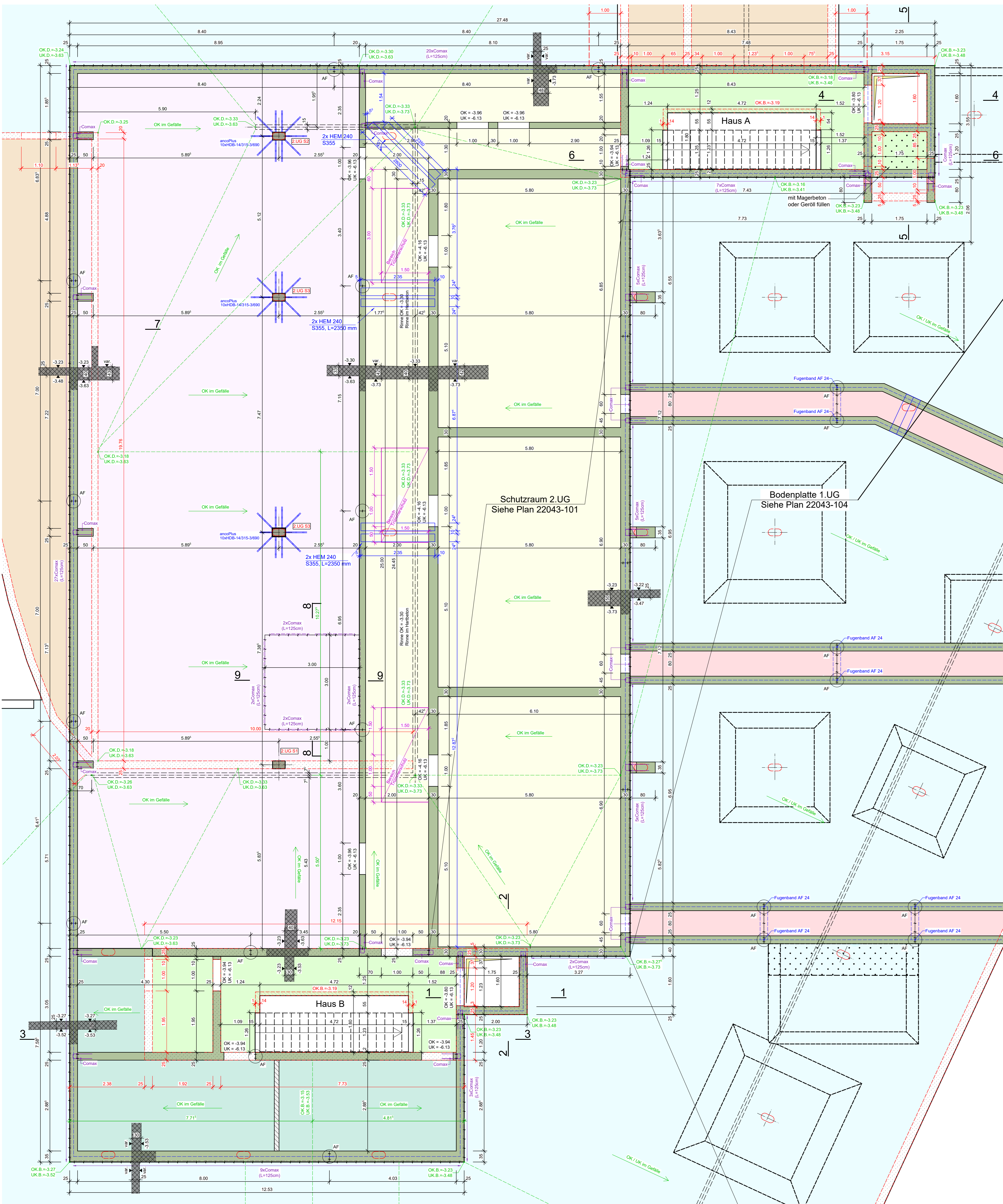

SCHNITT 1-1, 1:50

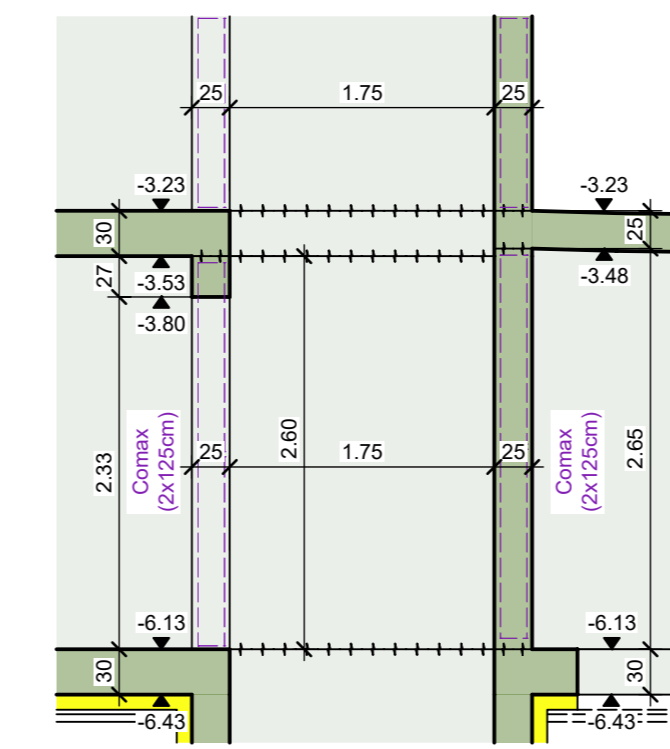

SCHNITT 2-2, 1:50

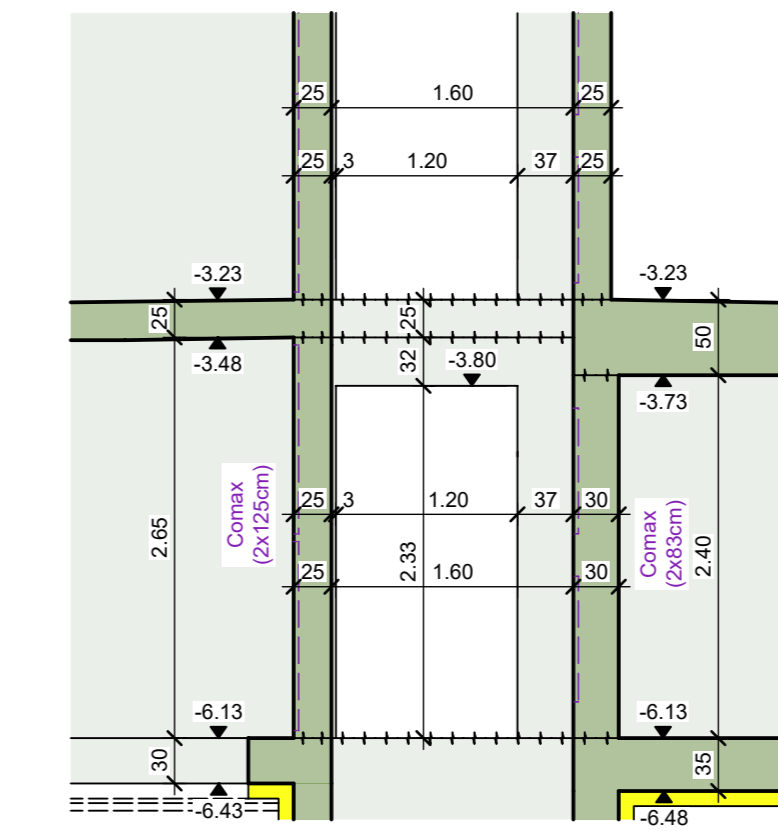

SCHNITT 3-3, 1:50

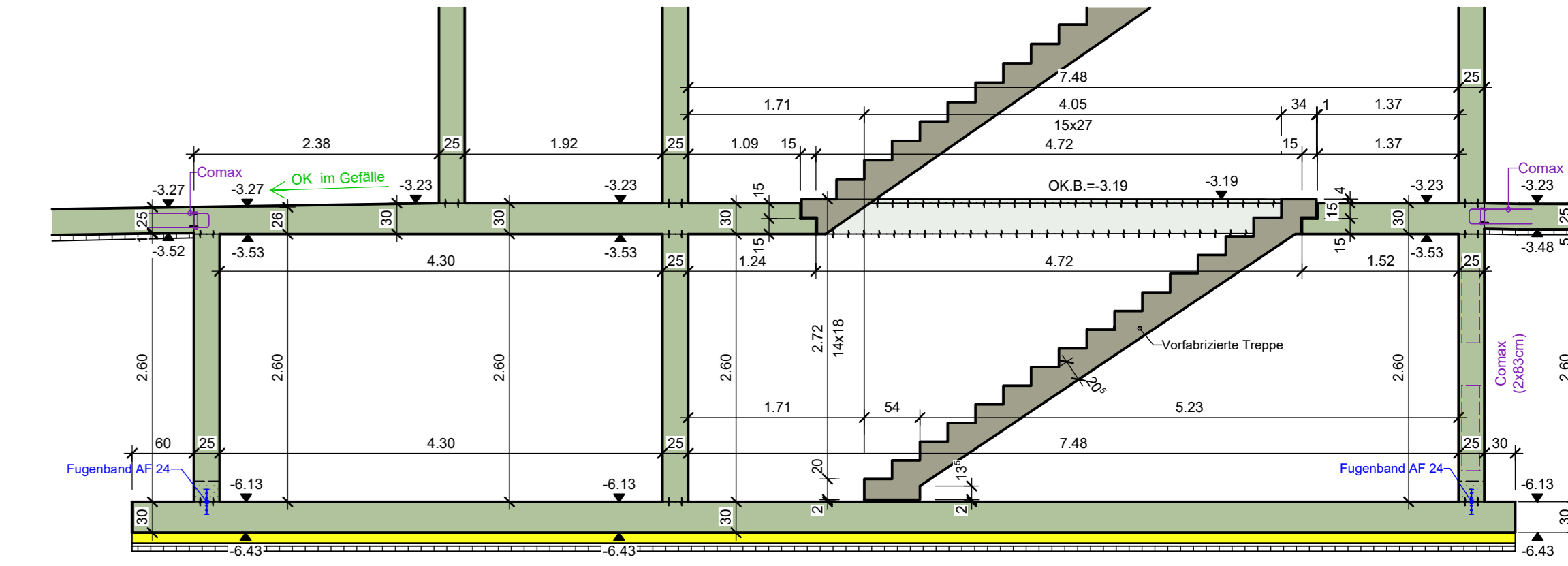

SCHNITT 4-4, 1:50

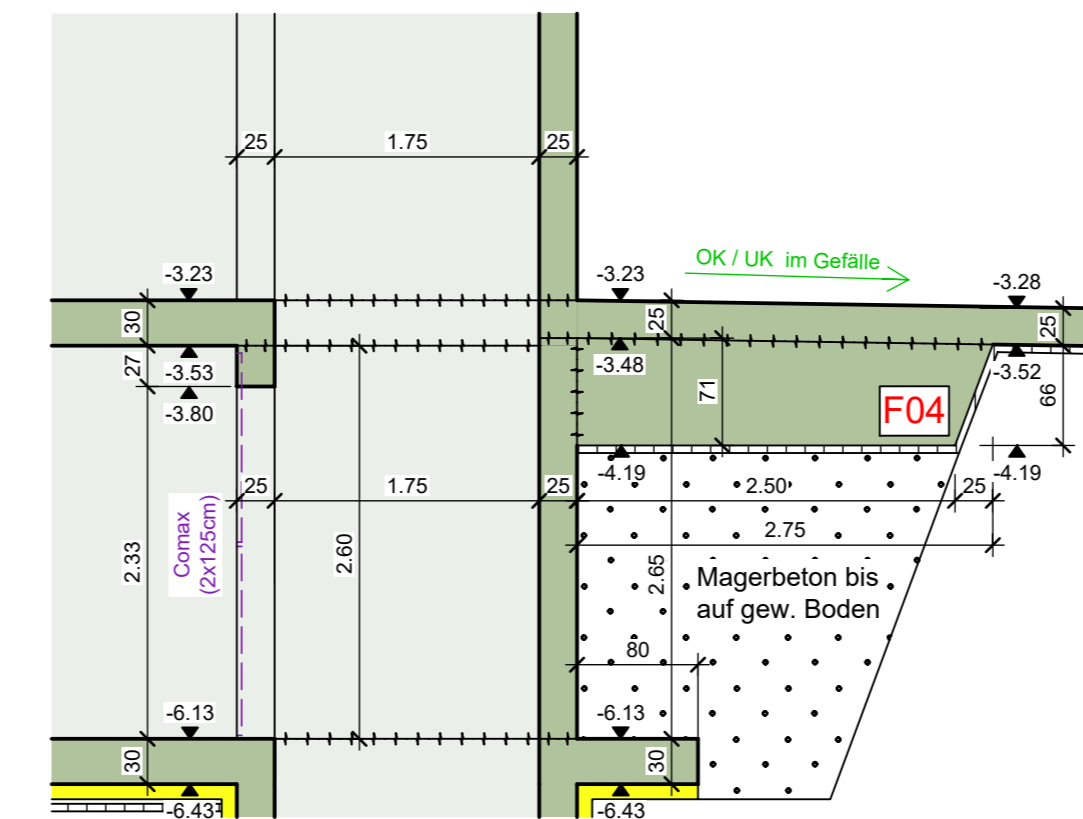

SCHNITT 5-5, 1:50

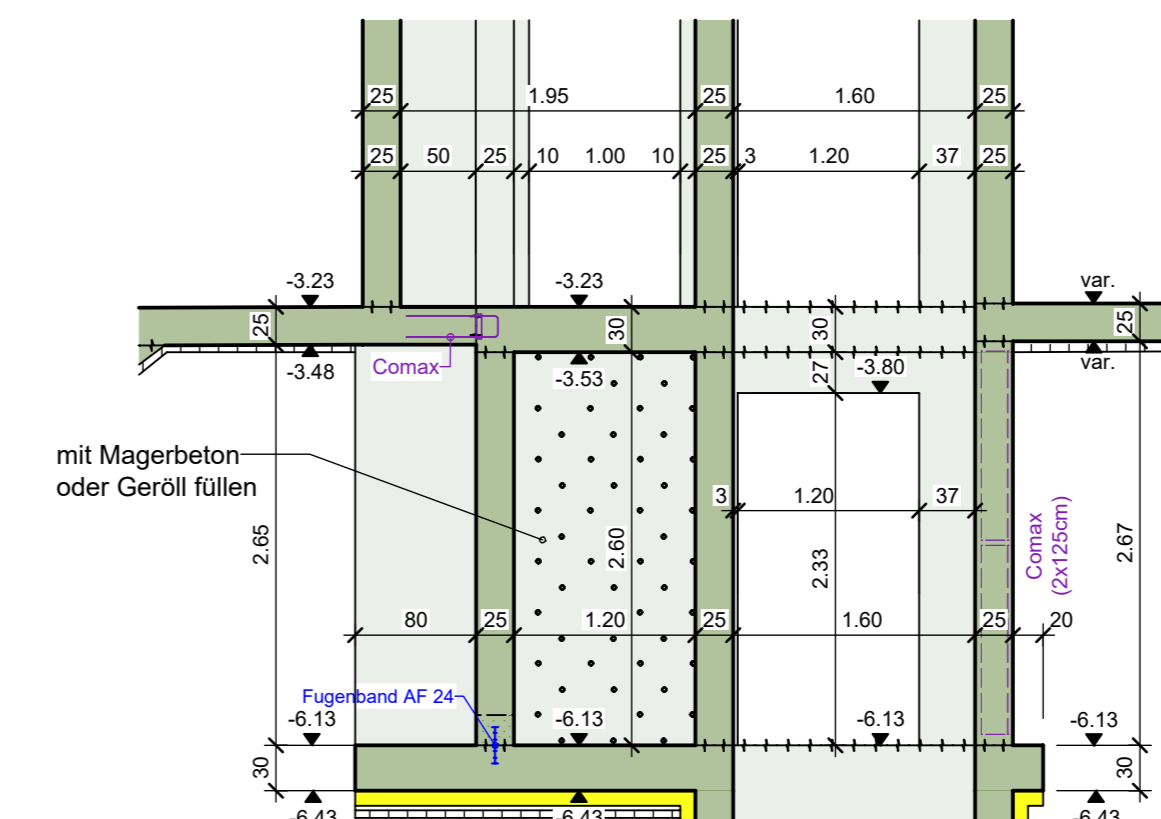

SCHNITT 6-6, 1:50

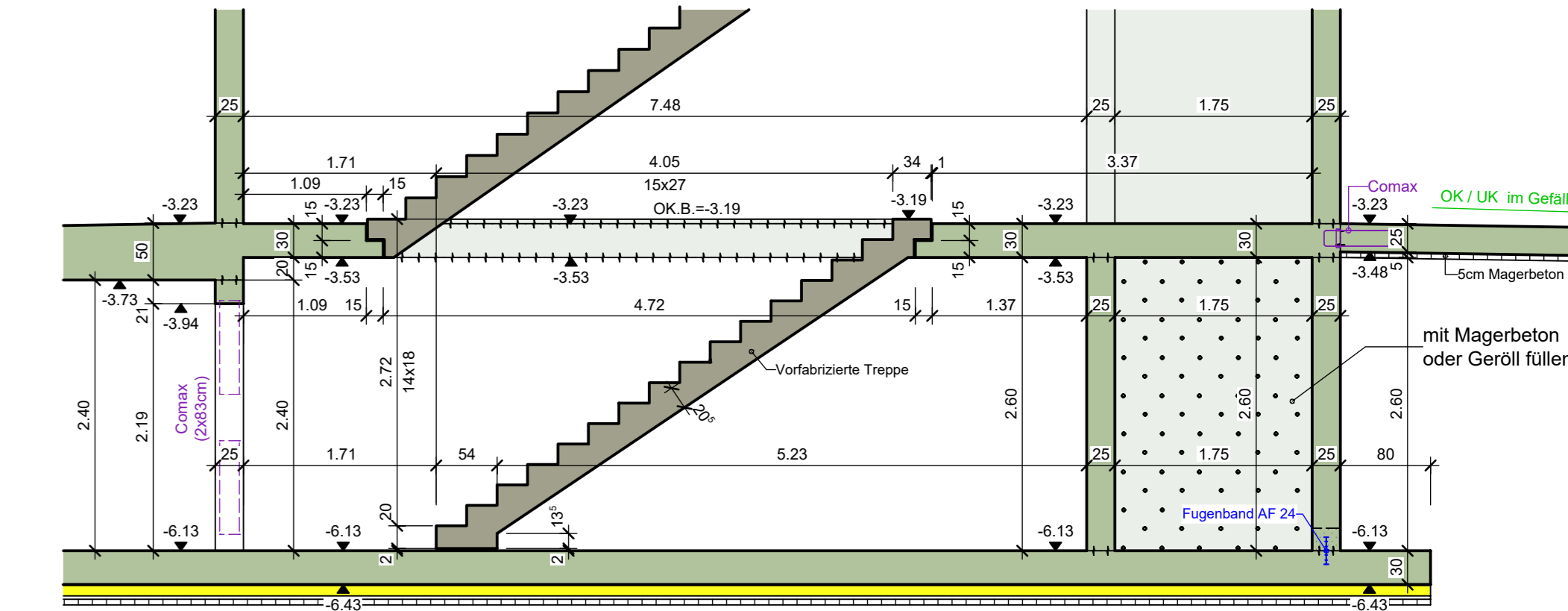

GRUNDRISS, 1:10
Vorfabrizierte Stütze 2.UG, S1+2.UG, S2
Fussdetail

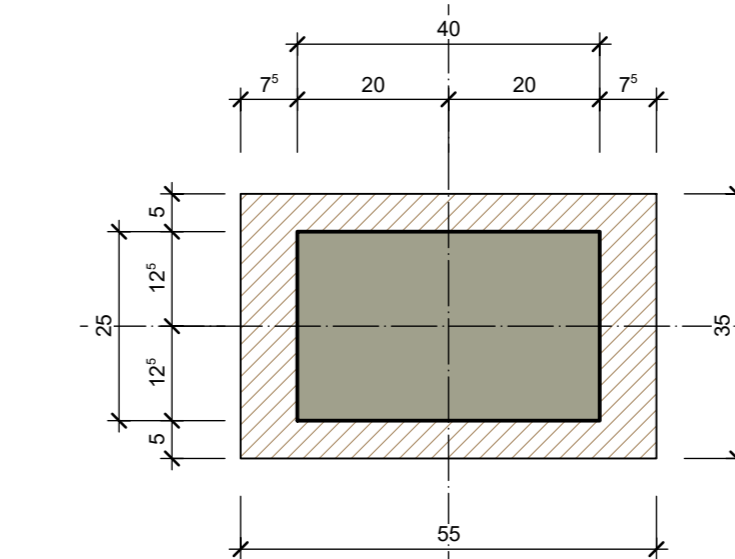

STÜTZE 2.UG, S1+2.UG, S2 1:20
Fussdetail

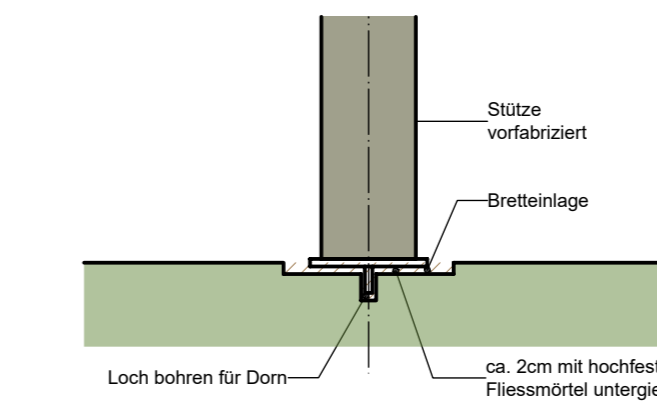

VORFABRIZIERTE STÜTZE 2.UG 1:20
Kopfdetail

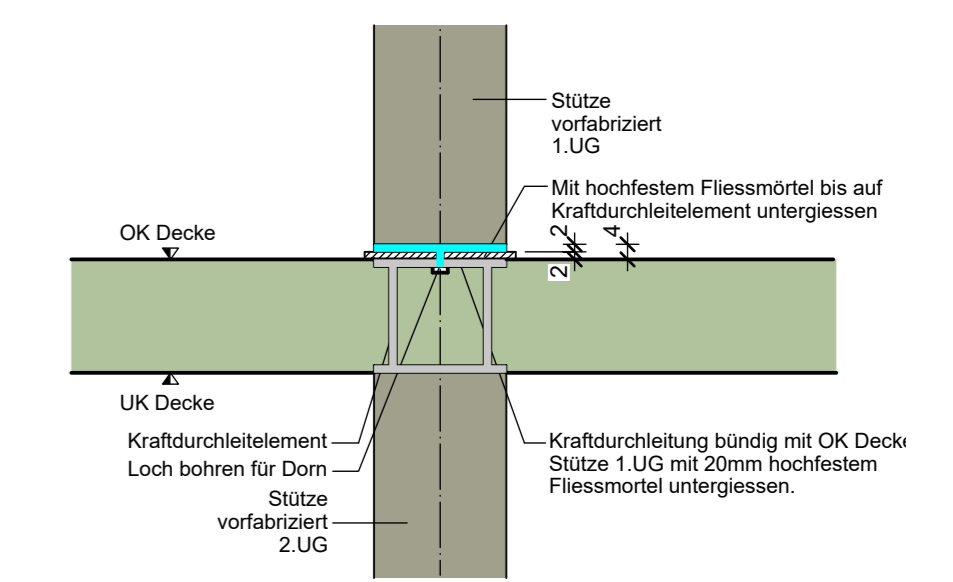

SCHNITT 7-7, 1:50

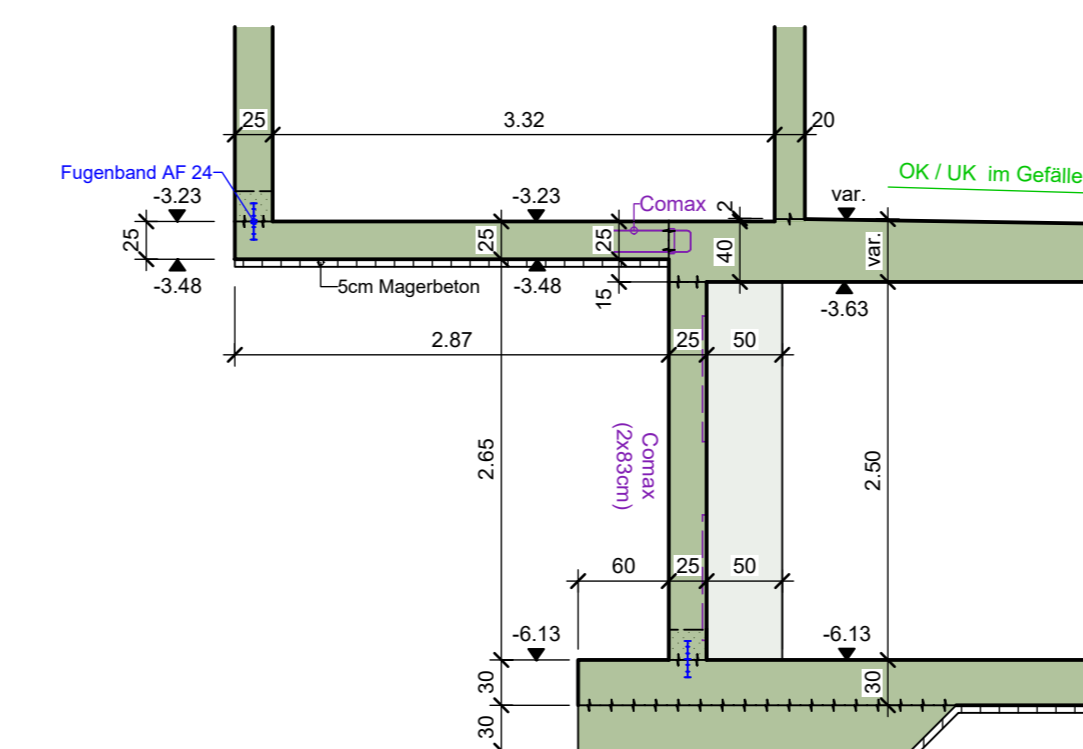

SCHNITT 8-8, 1:50

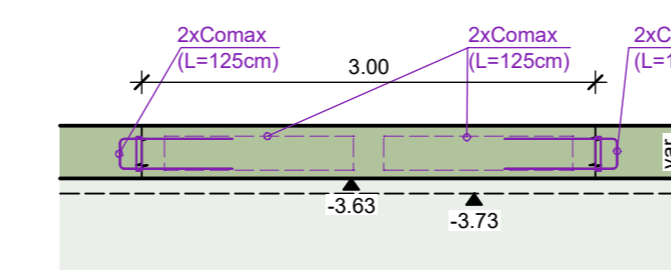

SCHNITT 9-9, 1:50

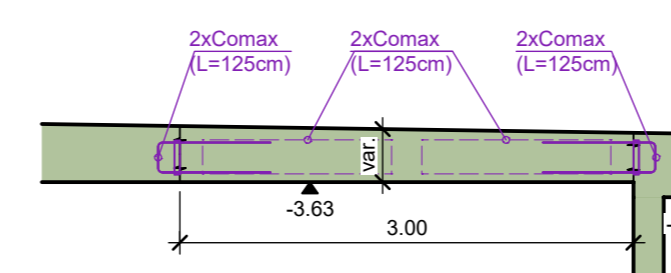

Detail 1:10
Stahlpilz

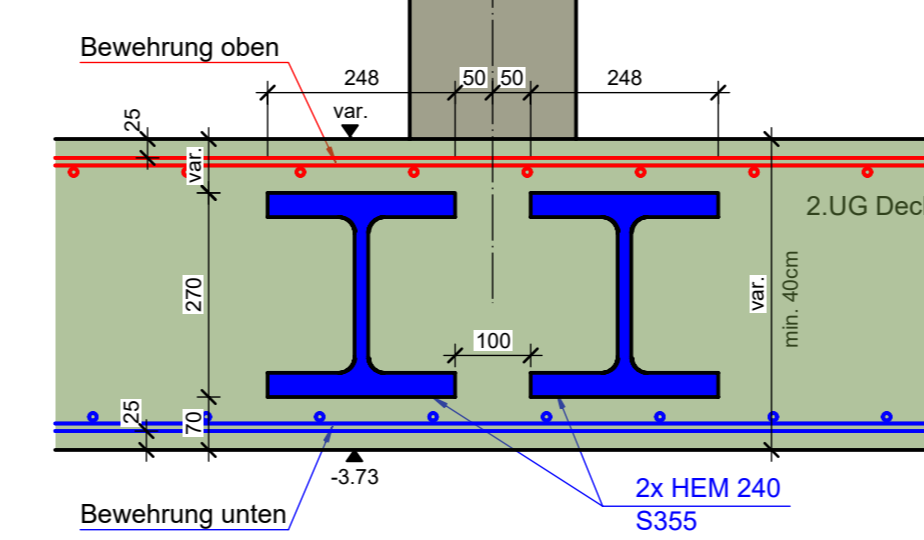

ETAPPEÜBERSICHT 1:200

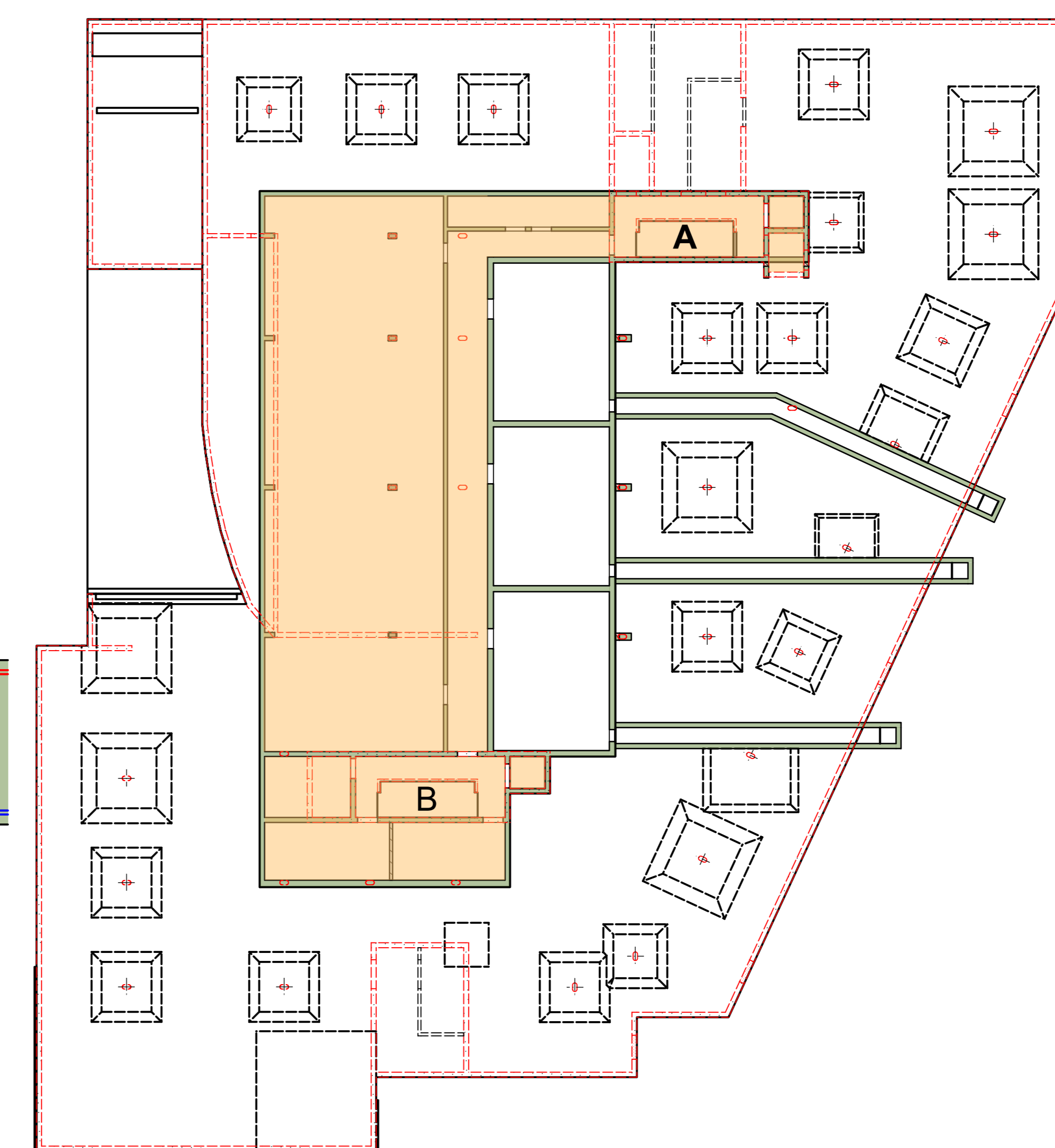

Decke d = 40-50cm OK.D = var UK.D = 3.77	Decke d = 30-45cm OK.D = var UK.D = 3.61	Decke d = 30cm OK.D = 3.23 UK.D = 3.61	Decke d = 25-35cm Nichtanstrich OK.D = var UK.D = 3.61	Decke d = 25-35cm OK.D = var UK.D = 3.53	Solerteile d = 25cm OK.B = var UK.B = 3.46	Solerteile d = 25cm OK.B = 3.23 UK.B = 3.46	Solerteile d = 25cm OK.B = 3.23 UK.B = 3.43
--	--	--	---	--	--	---	---

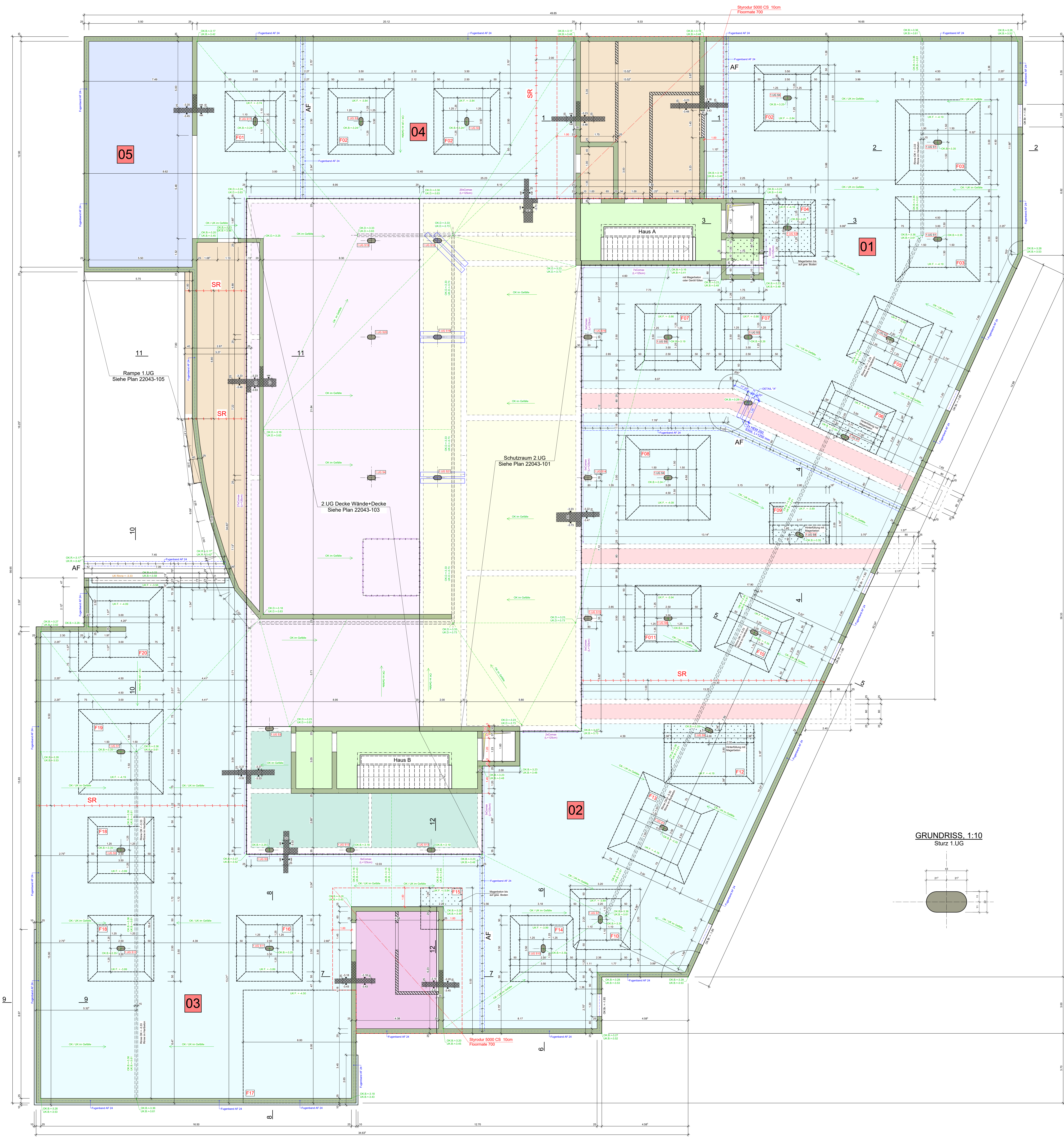

GRUNDRISS, 1:10
Sturz 1.UG

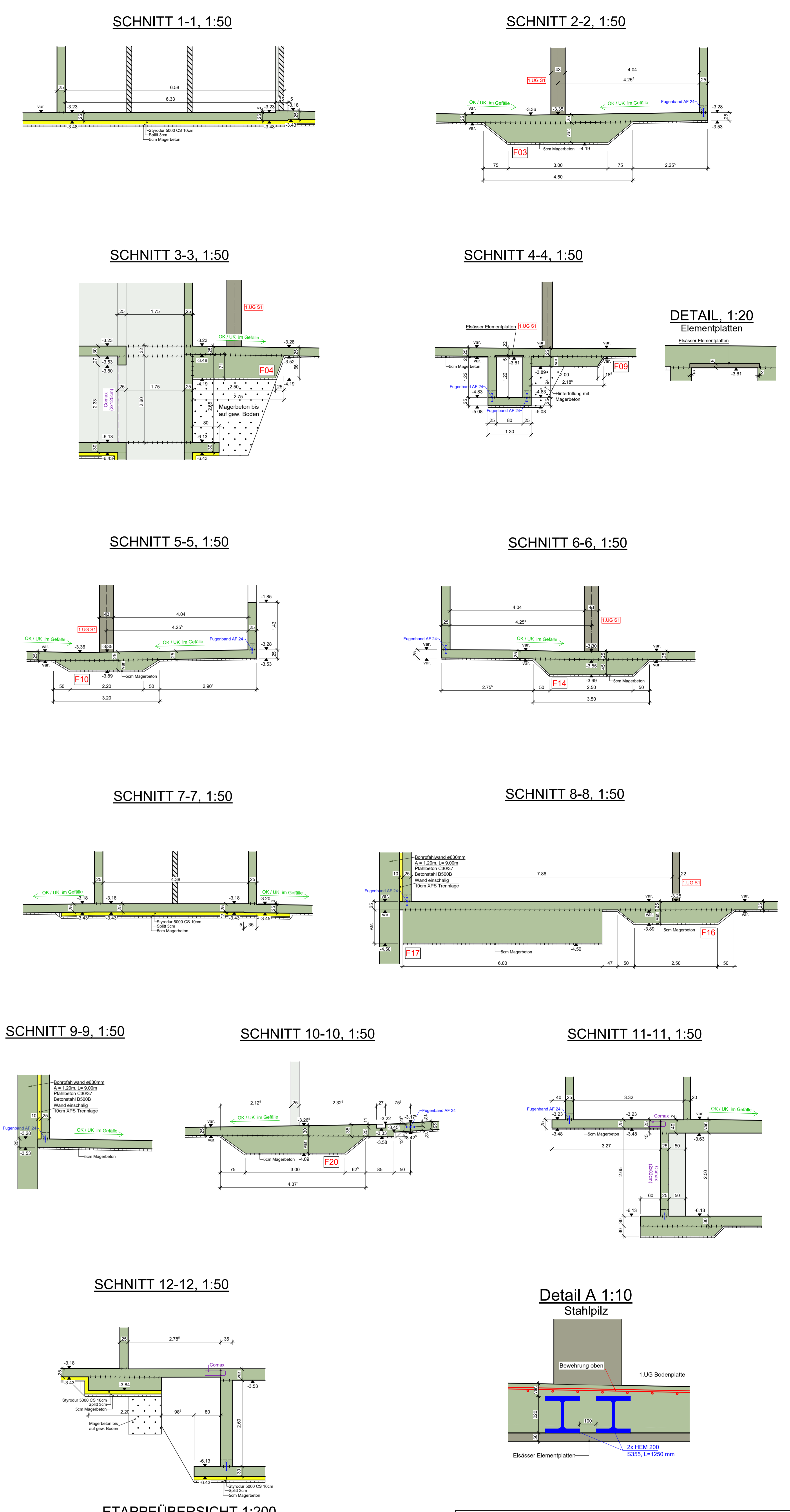
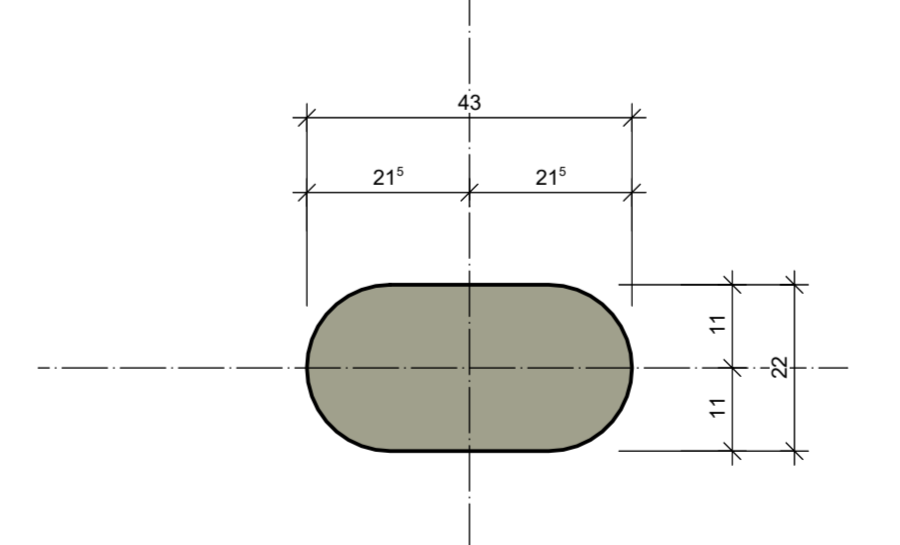

ETAPPEÜBERSICHT 1:200

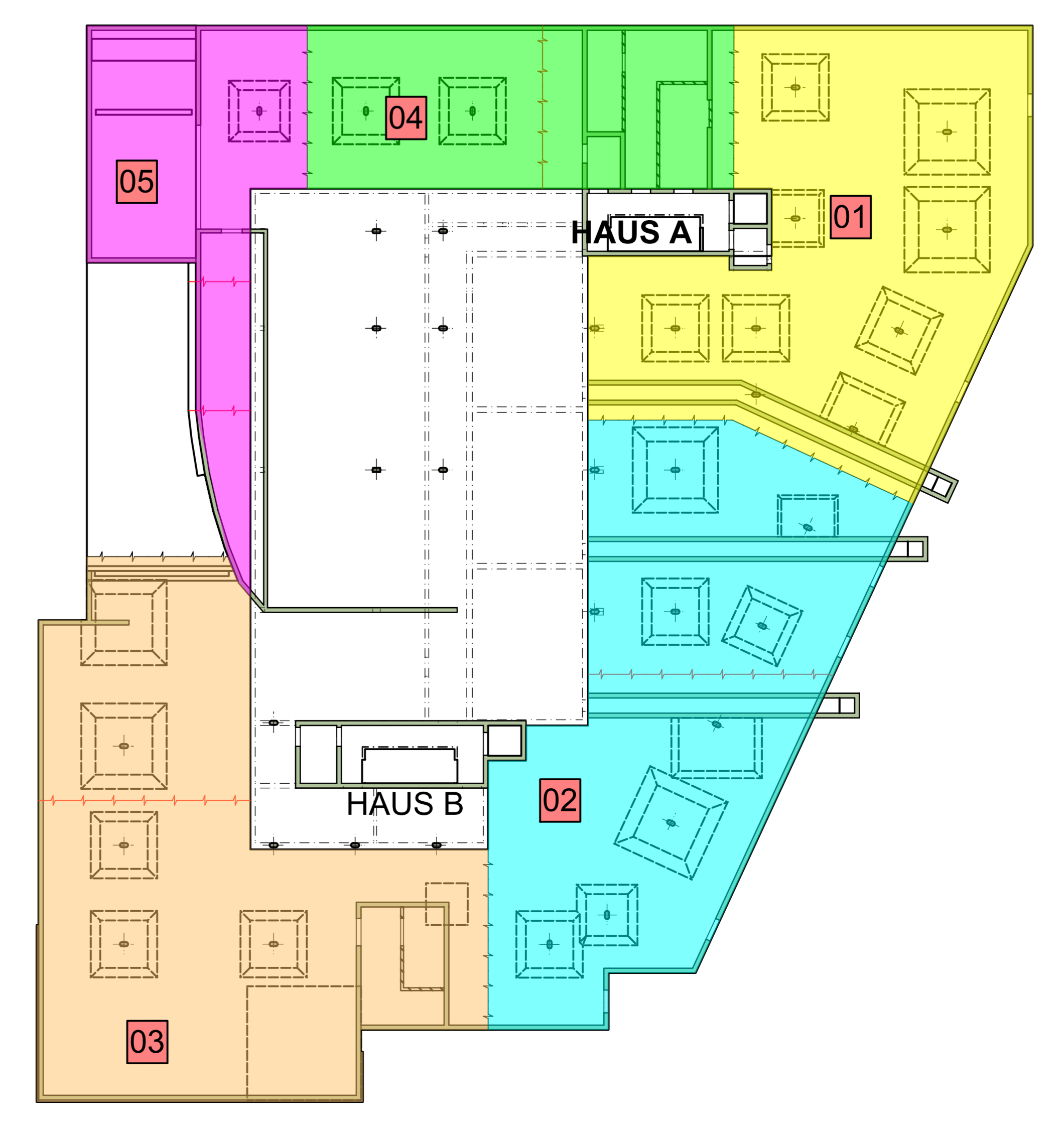

GRUNDRISS, 1:50

Decke d = 40cm OK.D. = +0.22 UK.D. = -0.02 UK.Dämmung = -0.07	Decke d = 64.5cm OK.D. = +0.22 UK.D. = -0.07	Decke d = var. OK.D. = var. UK.D. = -0.07 UK.Dämmung = -0.07	Decke d = 30-55cm OK.D. = var. UK.D. = -0.07	Decke d = 36.5-40cm OK.D. = var. UK.D. = -0.02	Decke d = 60.5-62cm OK.D. = var. UK.D. = -0.02
--	--	---	--	--	--

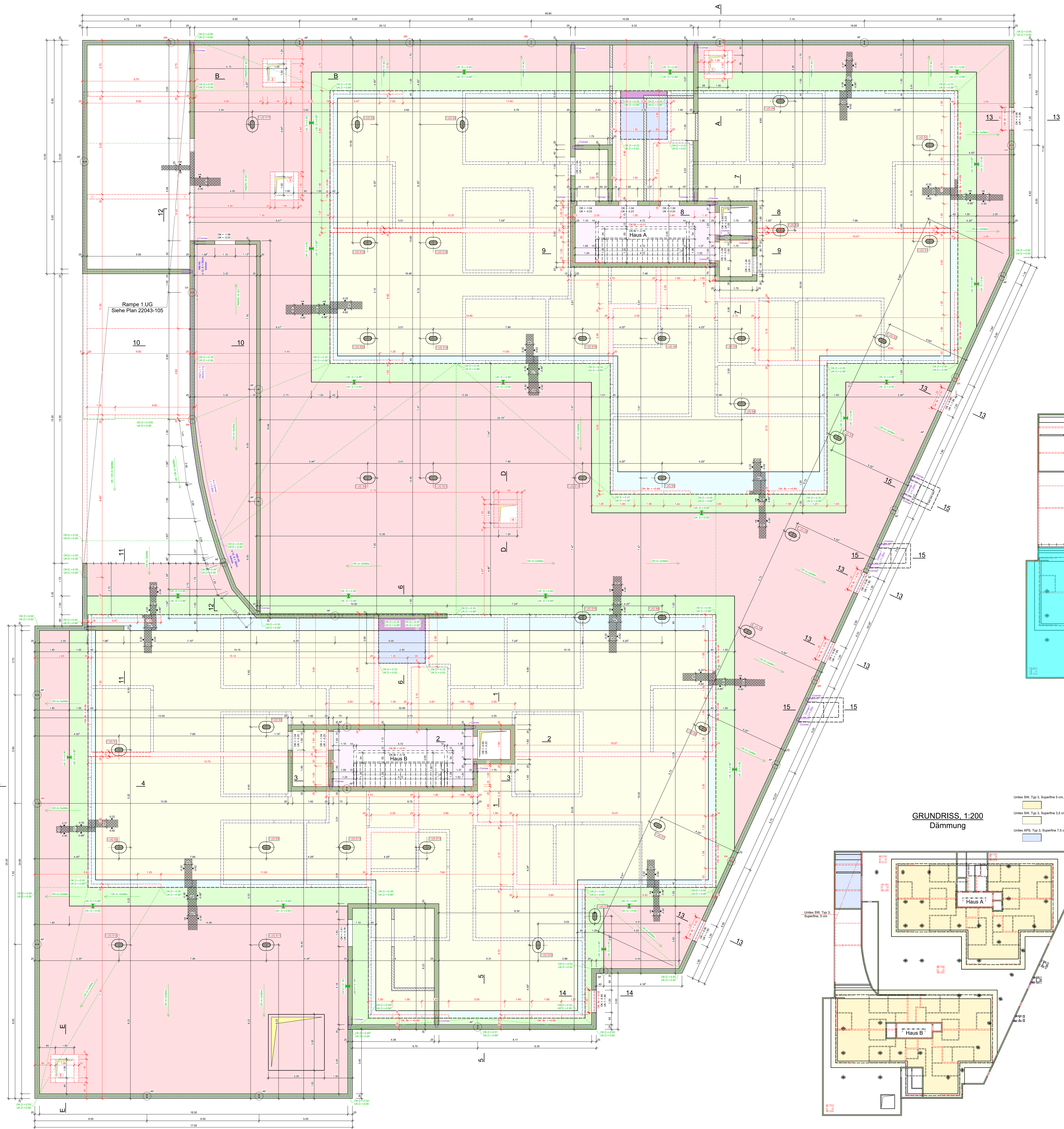

ÜBERSICHT 1:200

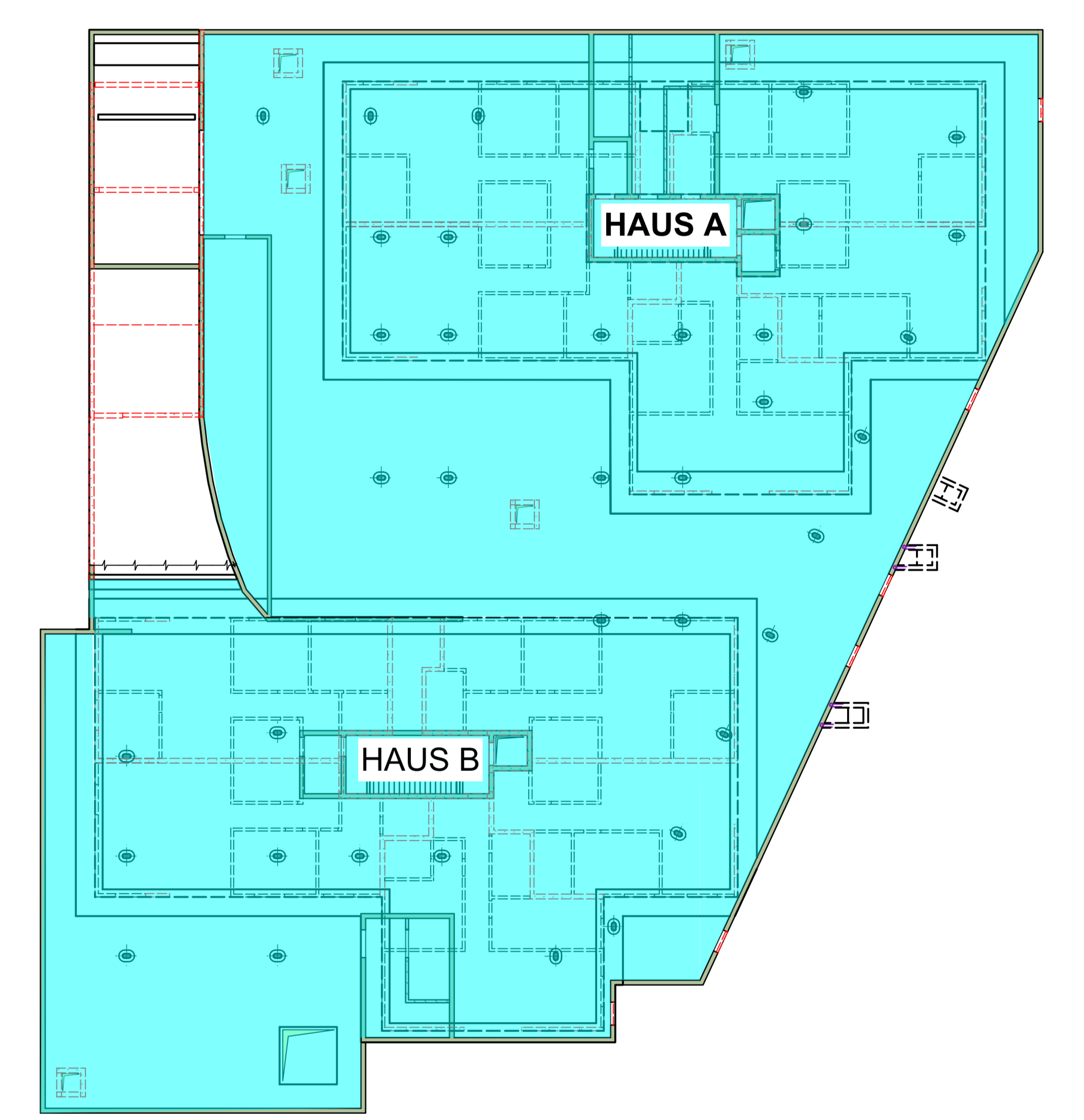

GRUNDRISS, 1:10

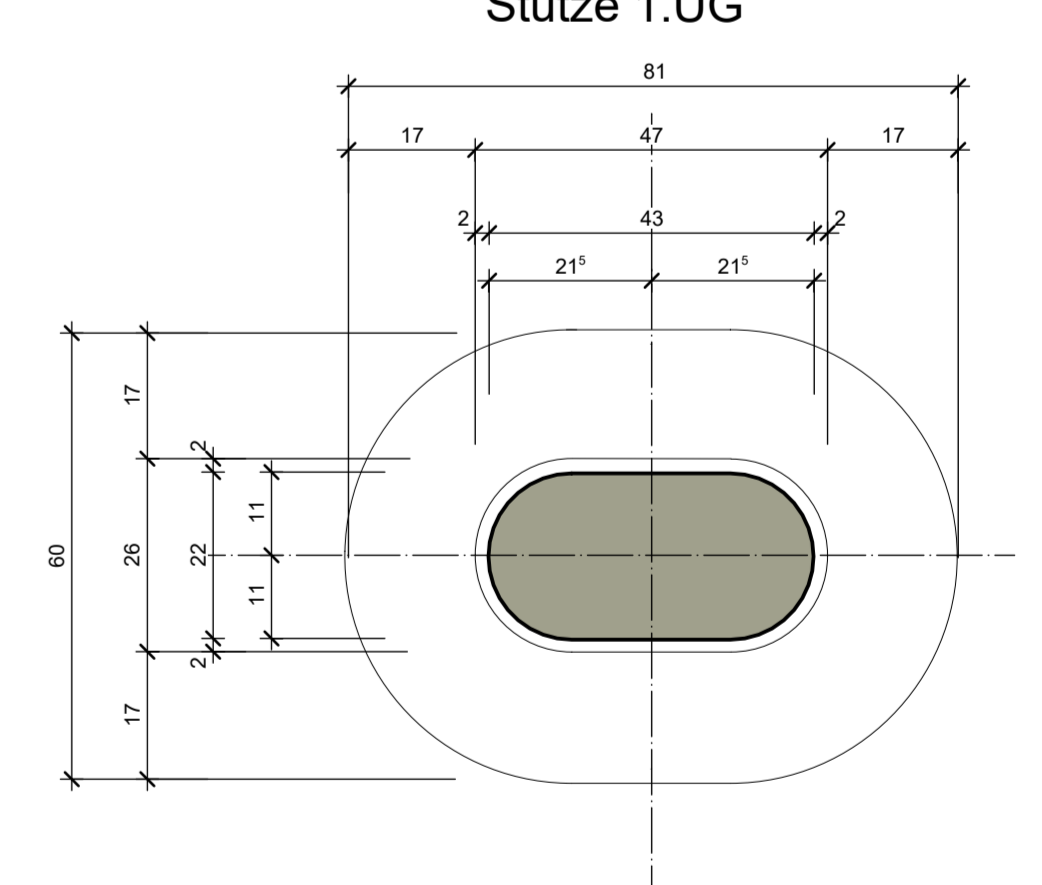

GRUNDRISS, 1:200

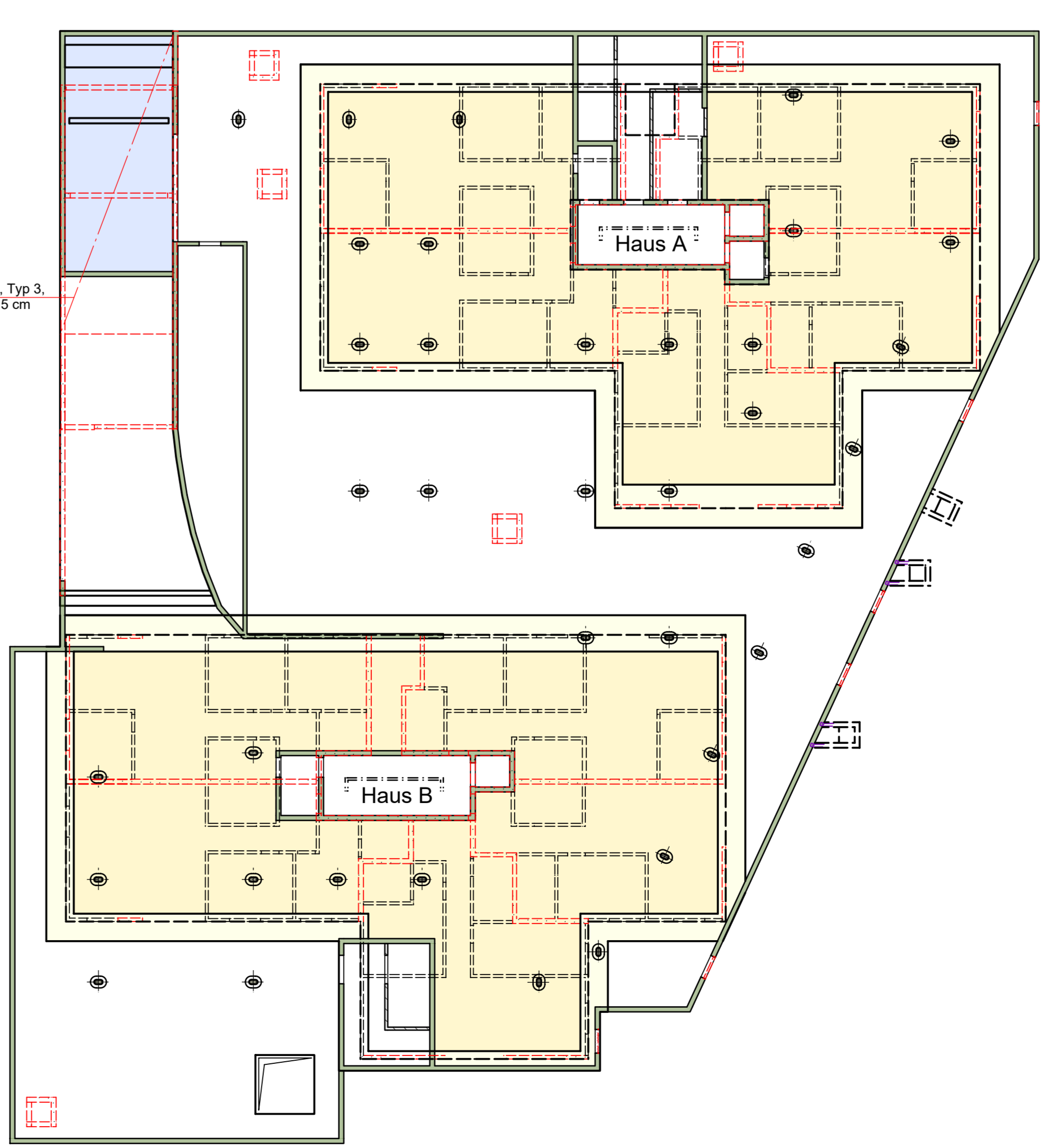

SCHNITT 1-1, 1:50

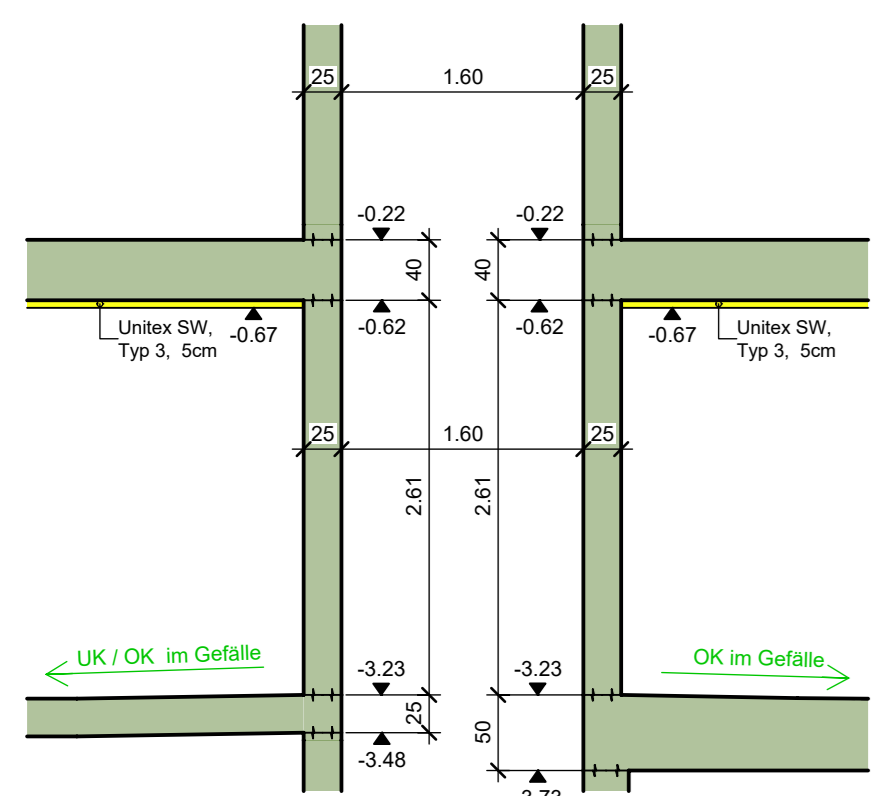

SCHNITT 2-2, 1:50

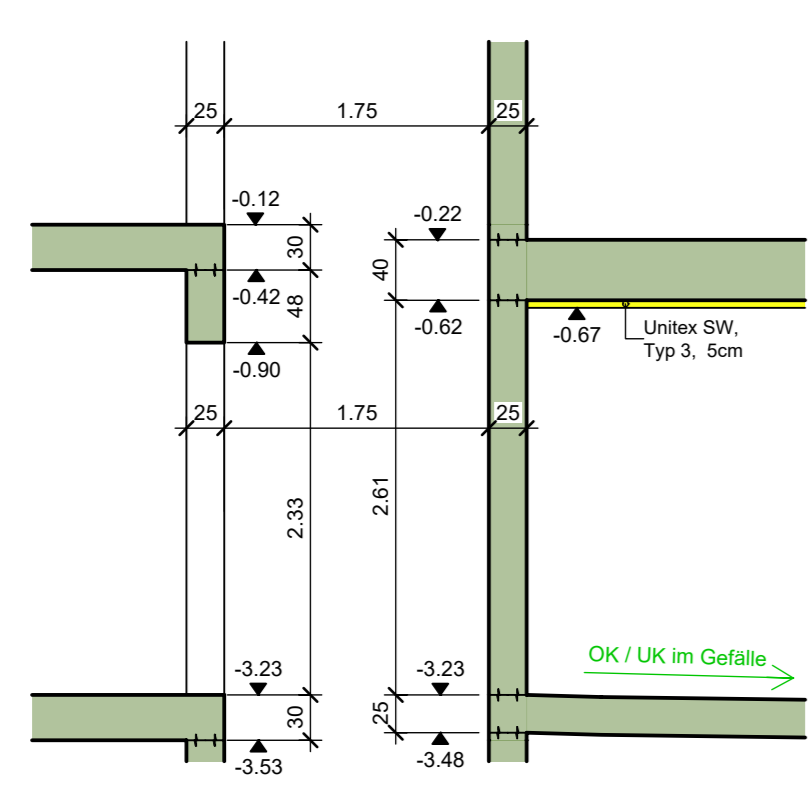

SCHNITT 3-3, 1:50

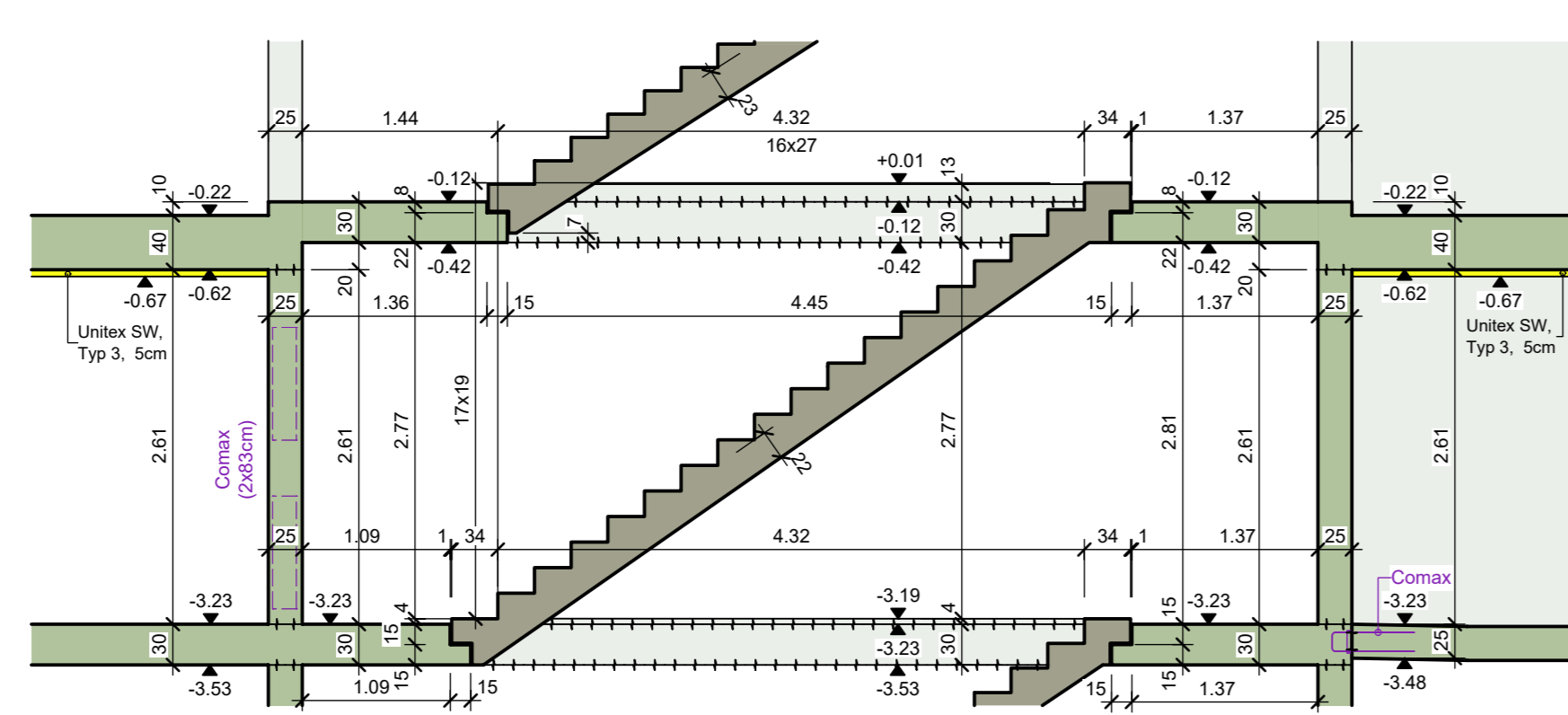

SCHNITT 4-4, 1:50

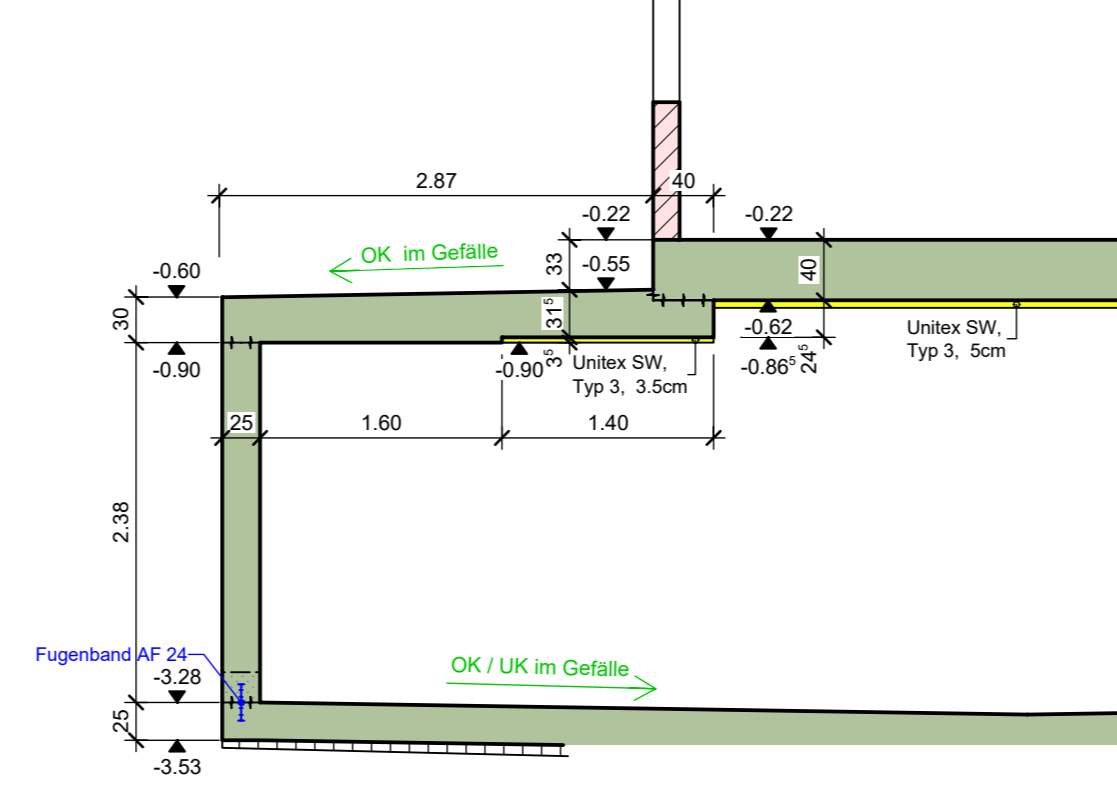

SCHNITT 5-5, 1:50

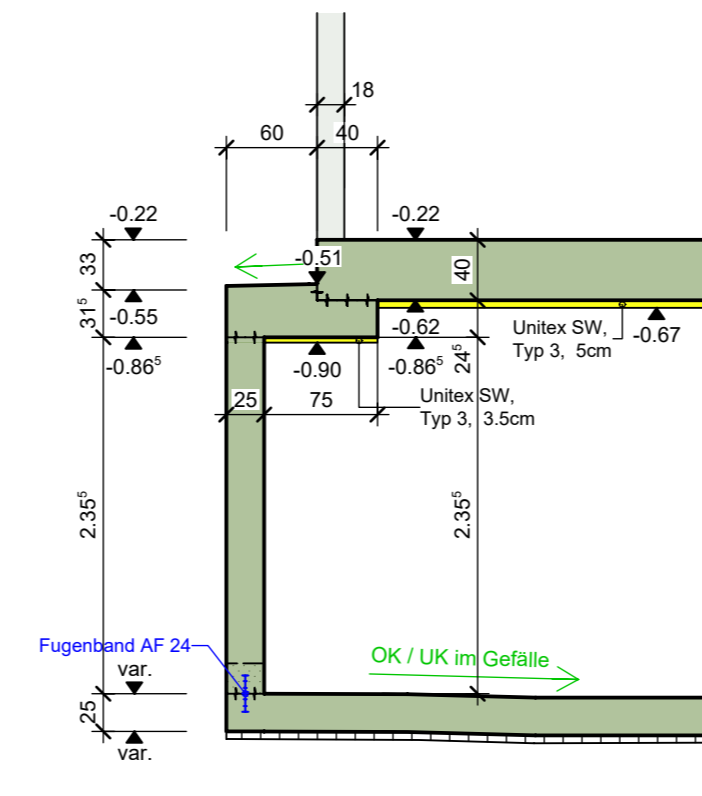

SCHNITT 6-6, 1:50

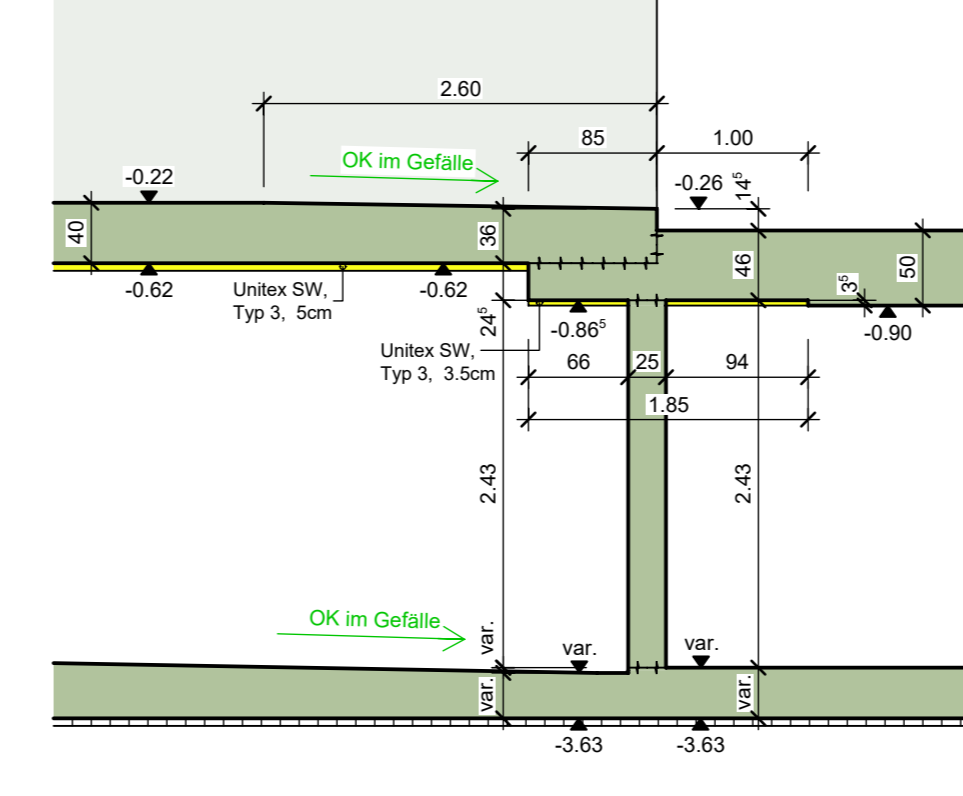

SCHNITT 7-7, 1:50

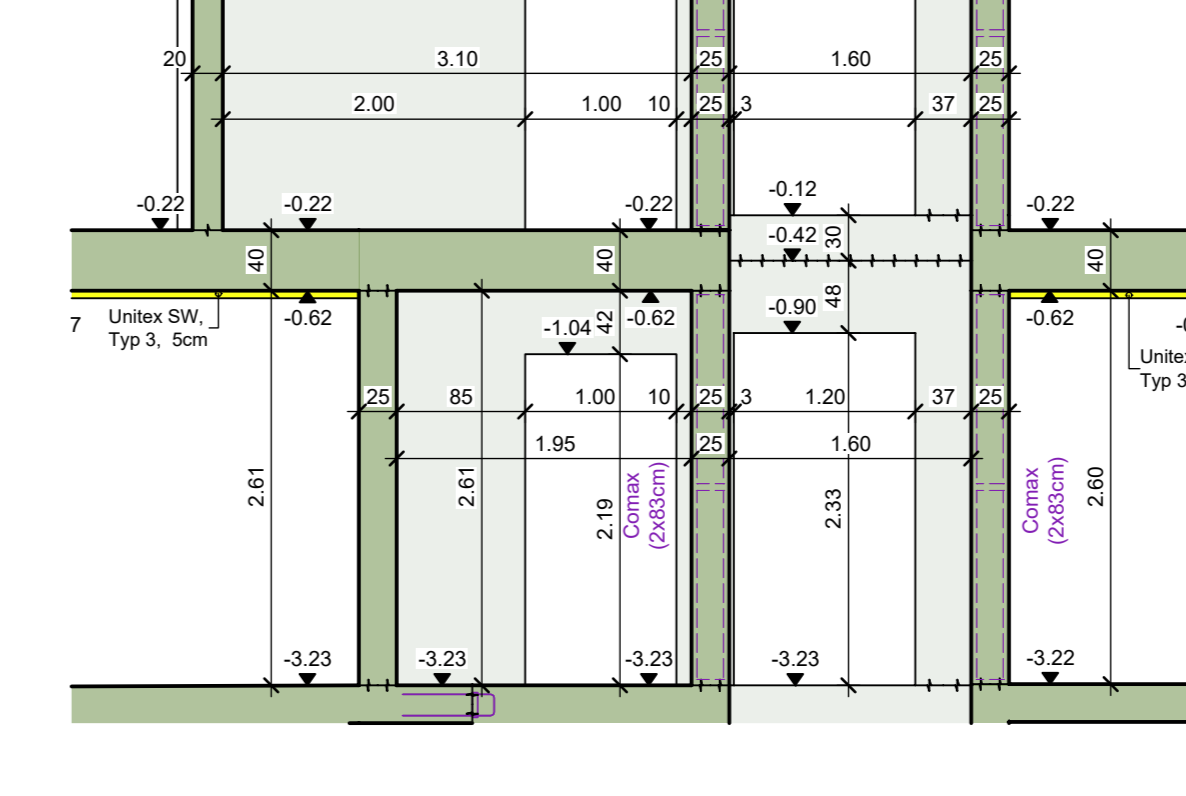

ÜBERSICHT 1:200

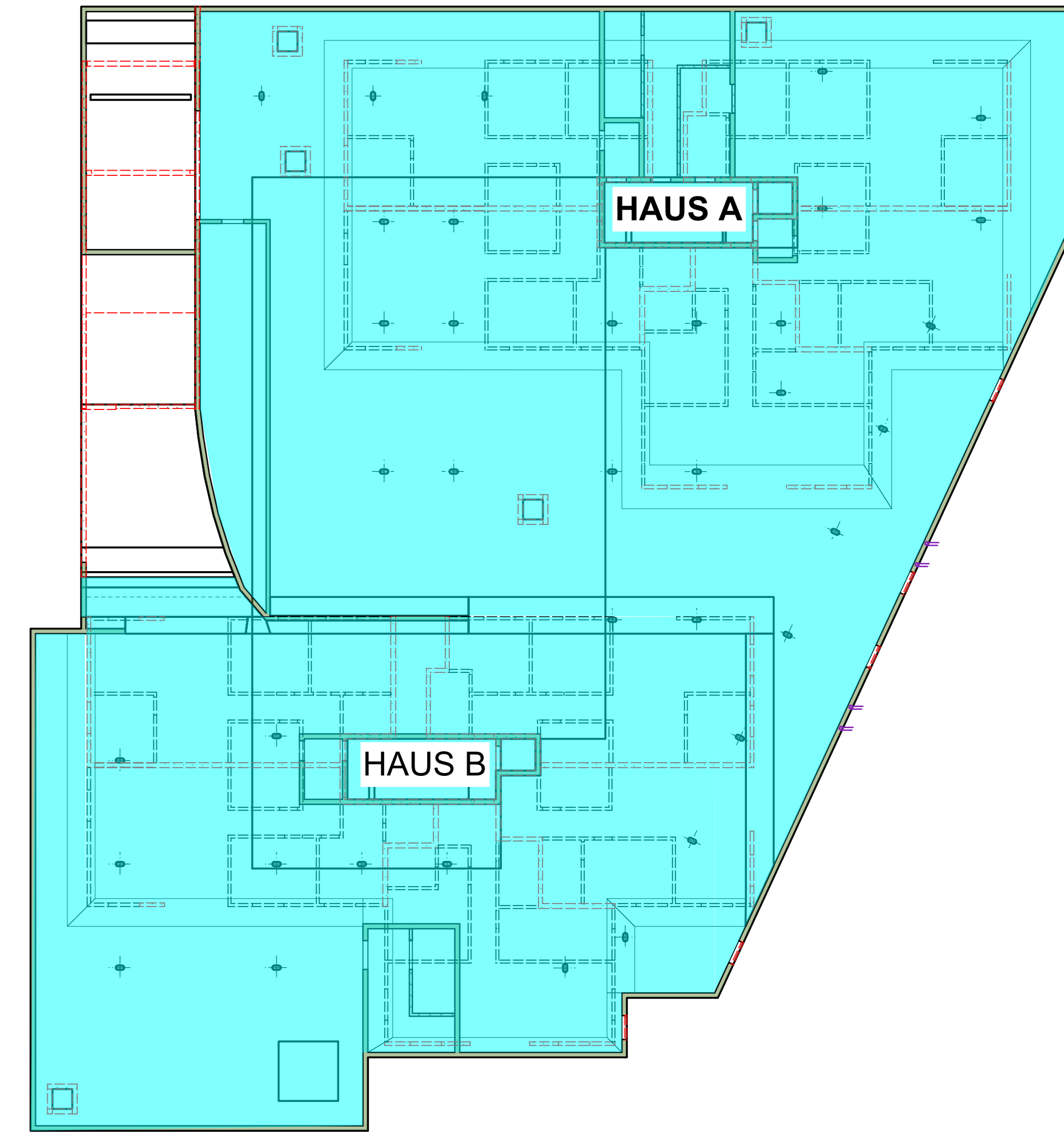

SCHNITT 8-8, 1:50

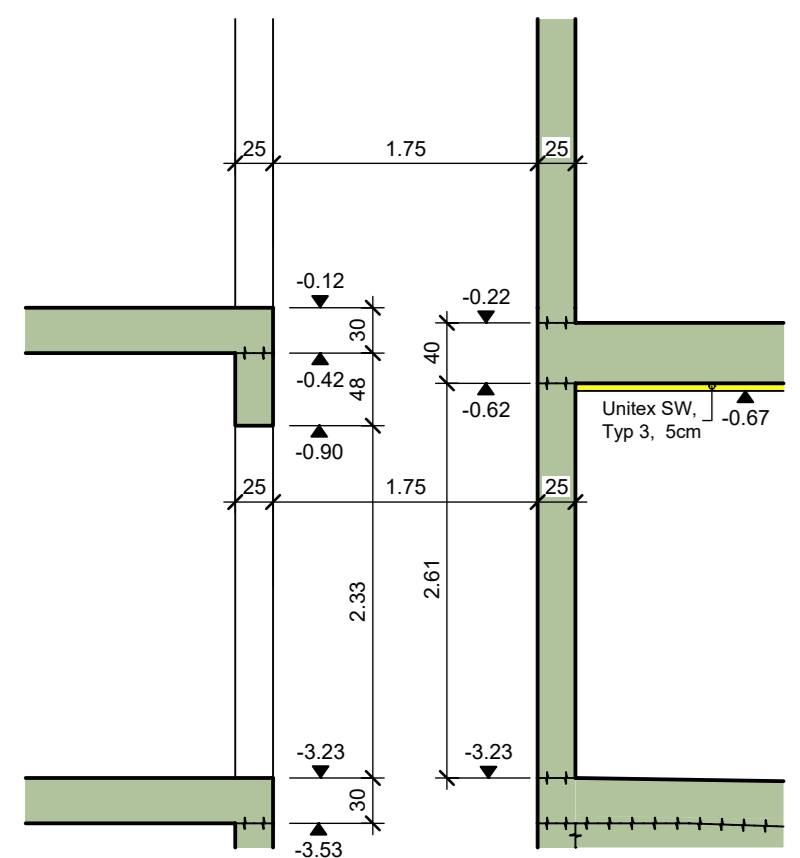

SCHNITT 9-9, 1:50

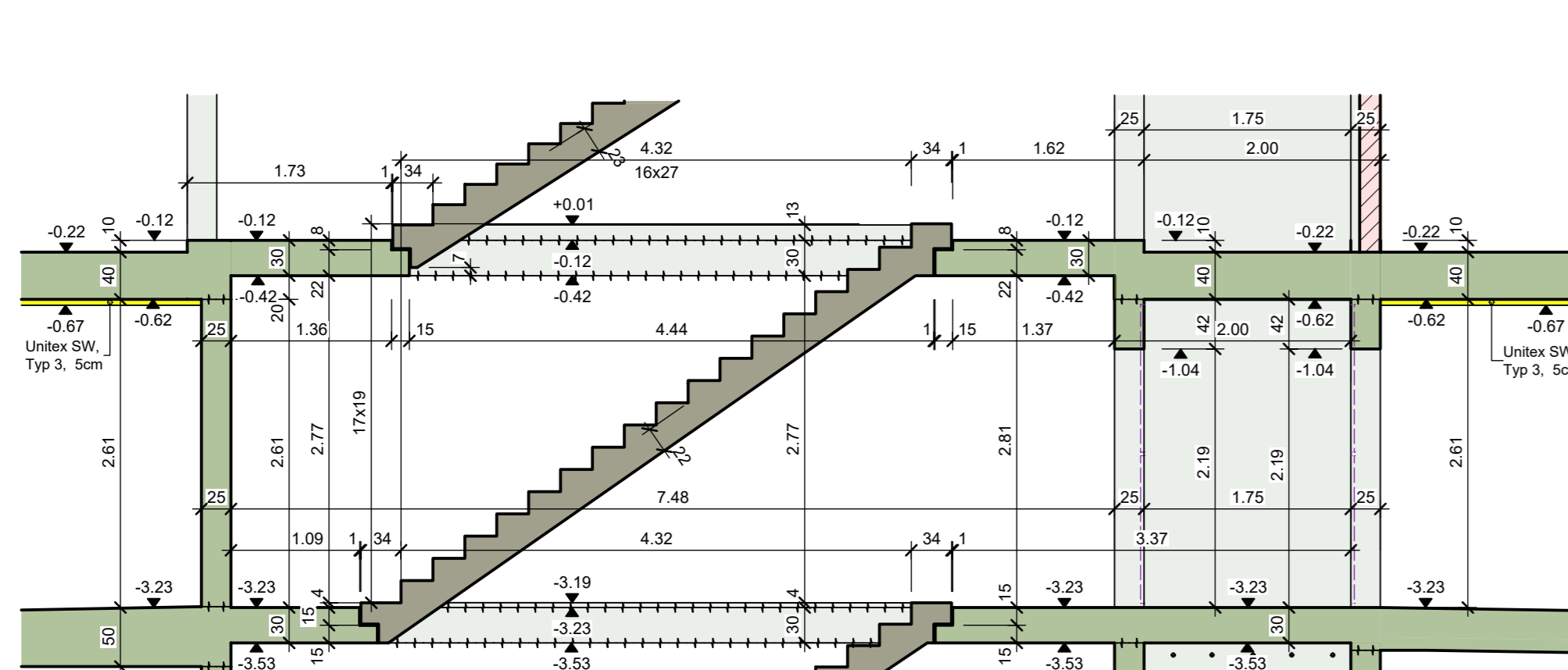

SCHNITT 10-10, 1:50

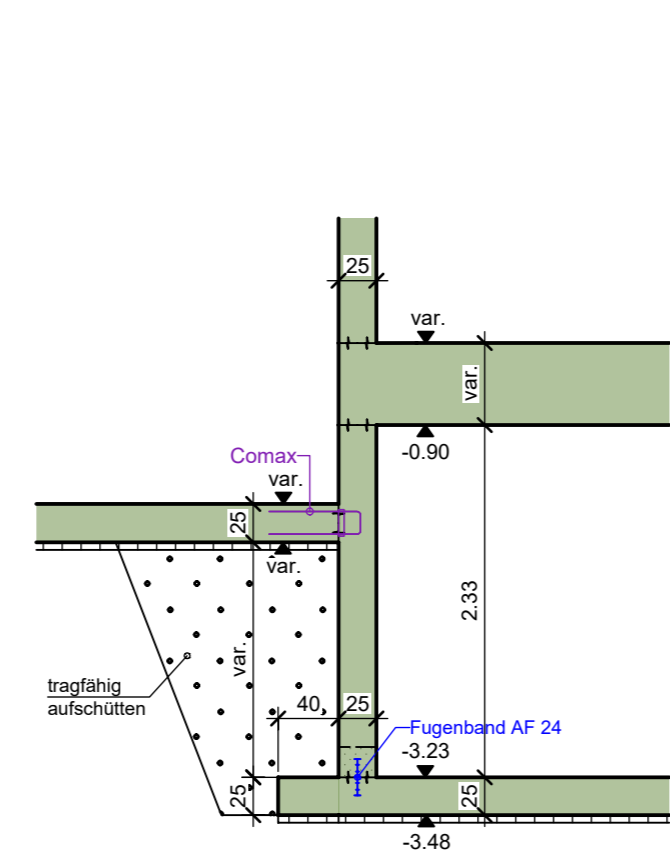

SCHNITT 11-11, 1:50

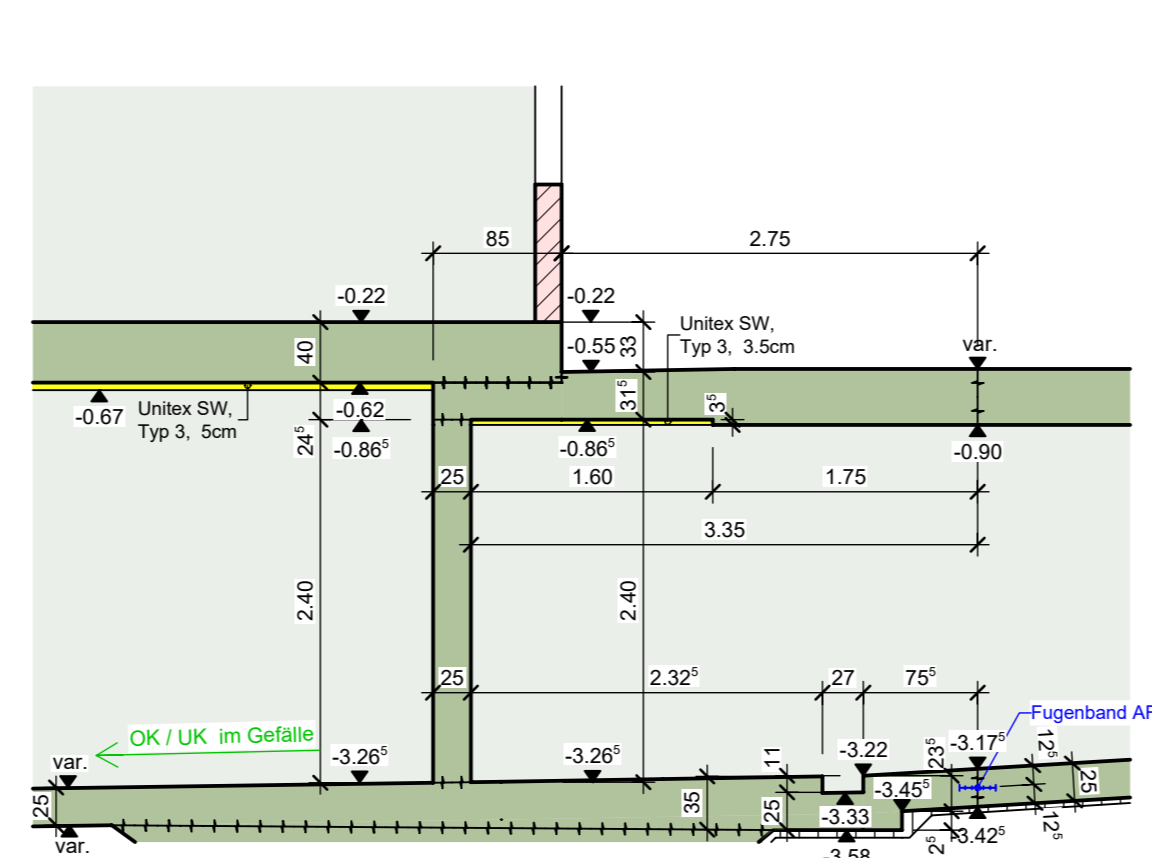

SCHNITT 12-12, 1:50

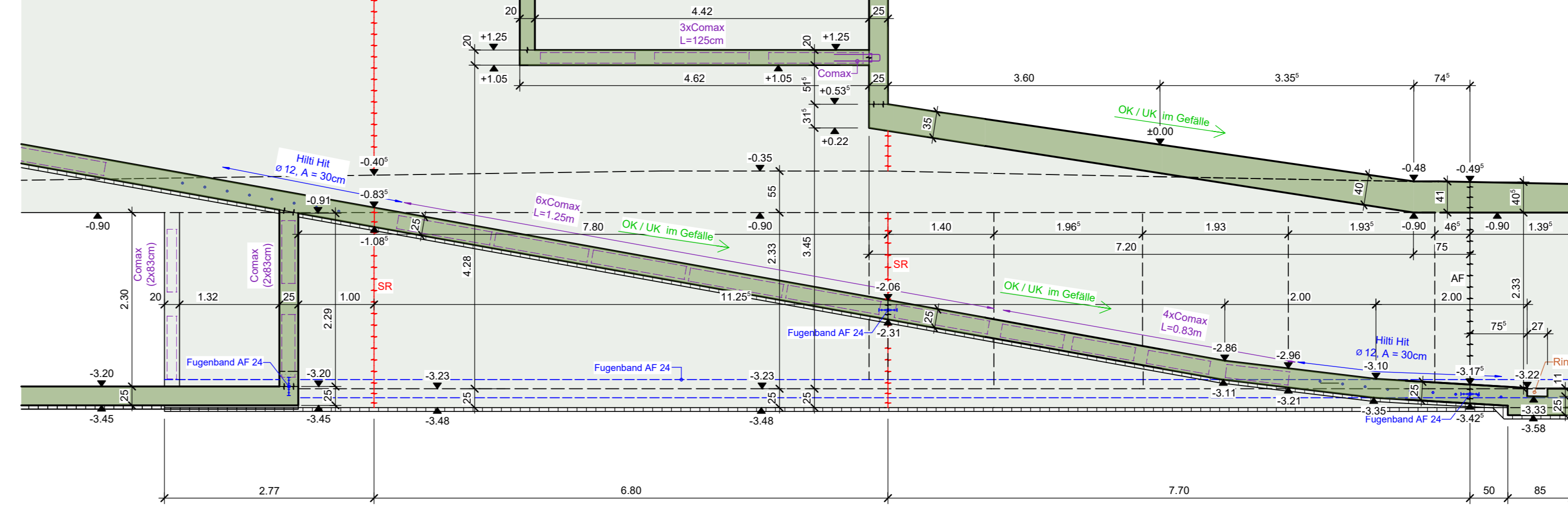

SCHNITT 14-14, 1:50

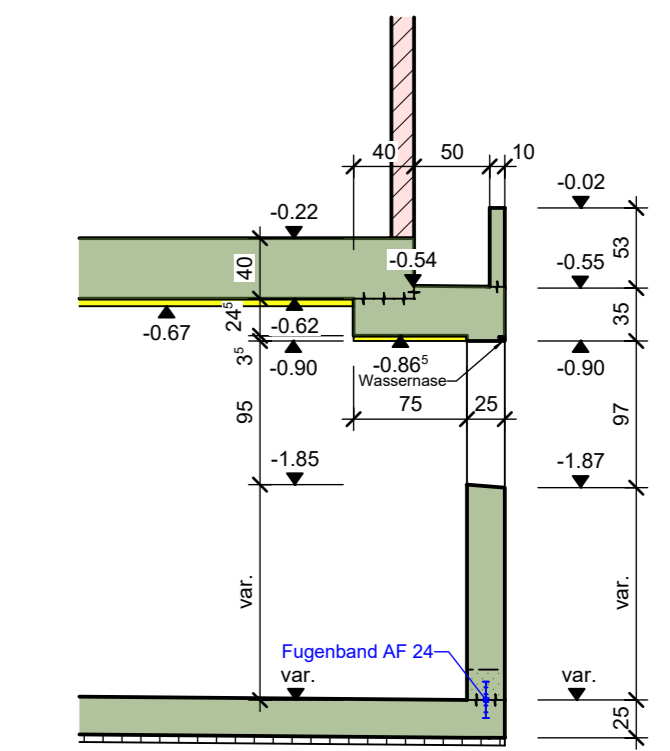

SCHNITT 15-15, 1:50

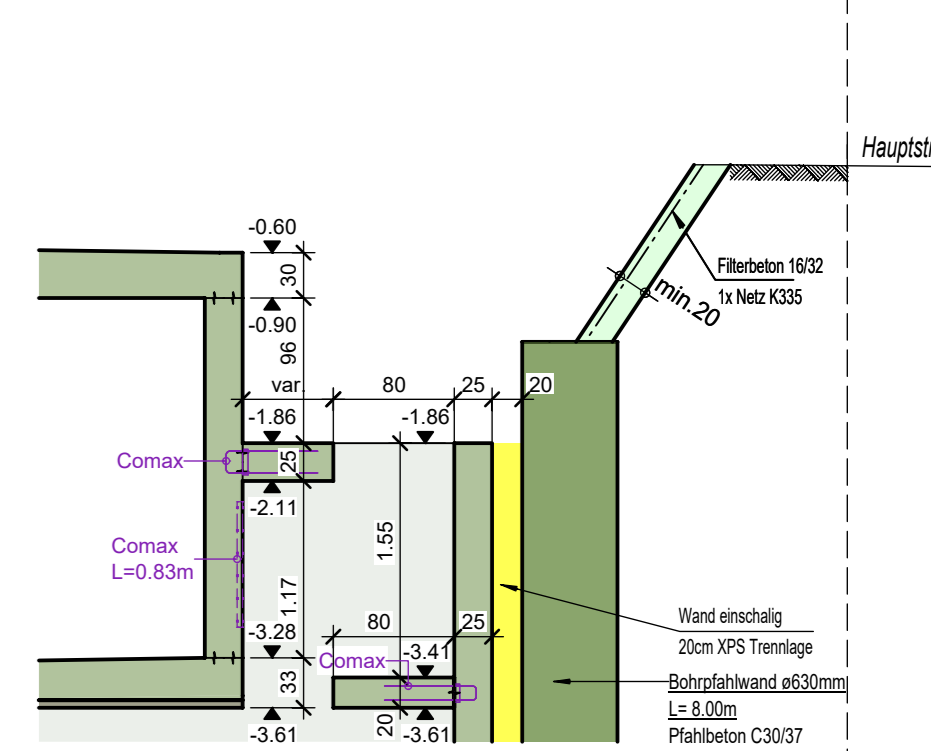

GRUNDRISS 1:25 Nachstromöffnungen "1"

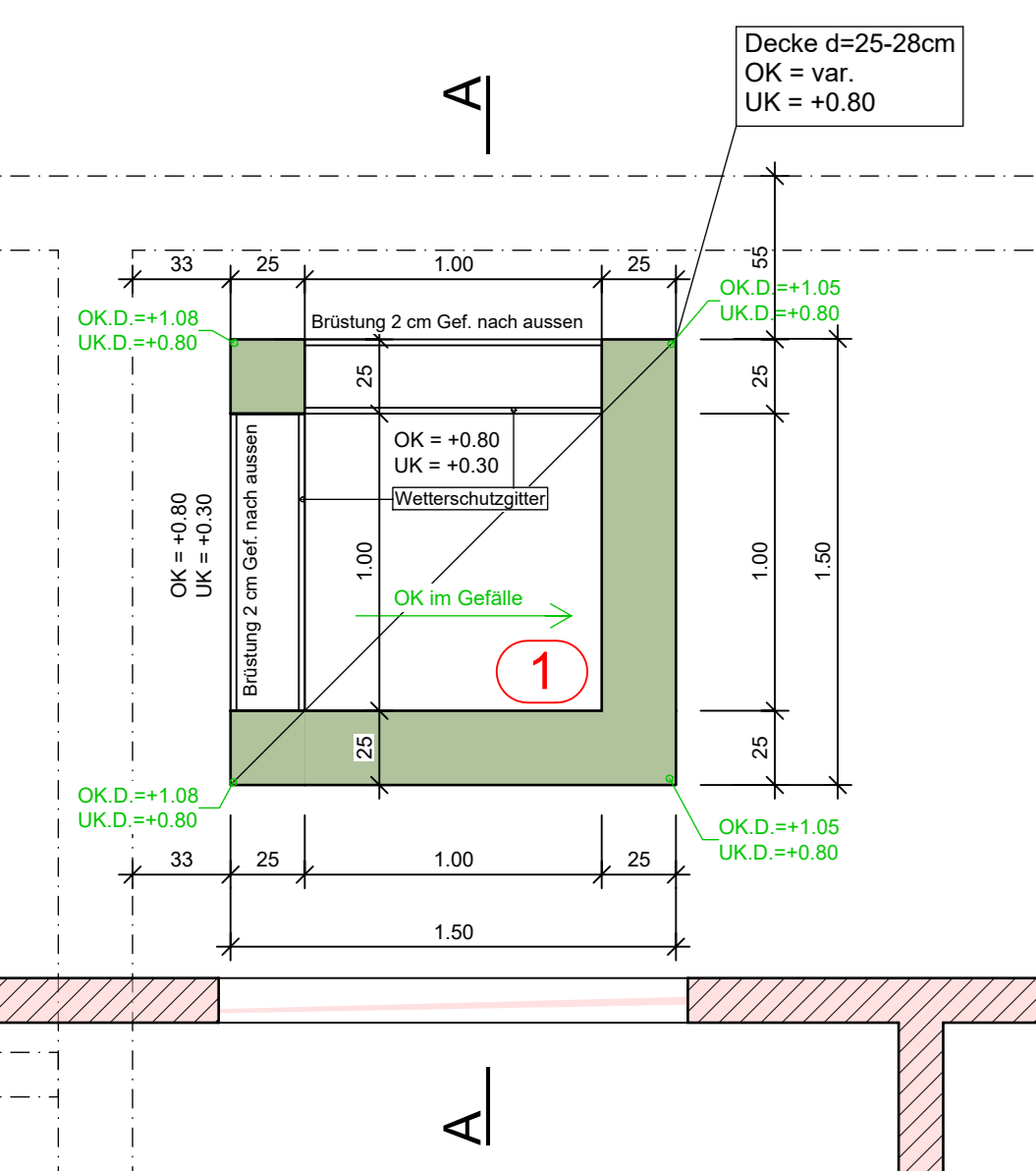

GRUNDRISS 1:25 Nachstromöffnungen "2"

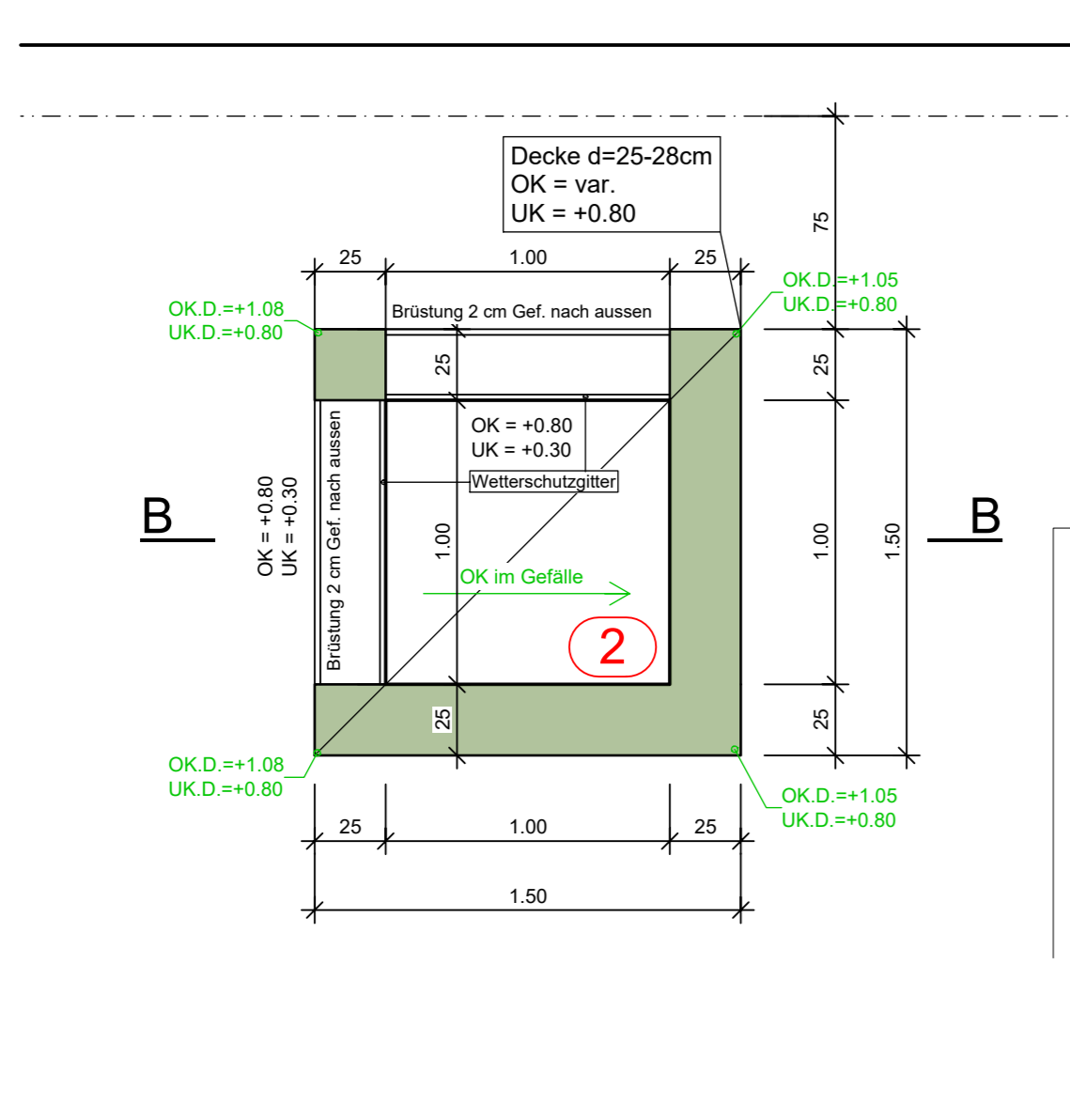

GRUNDRISS 1:25 Nachstromöffnungen "3"

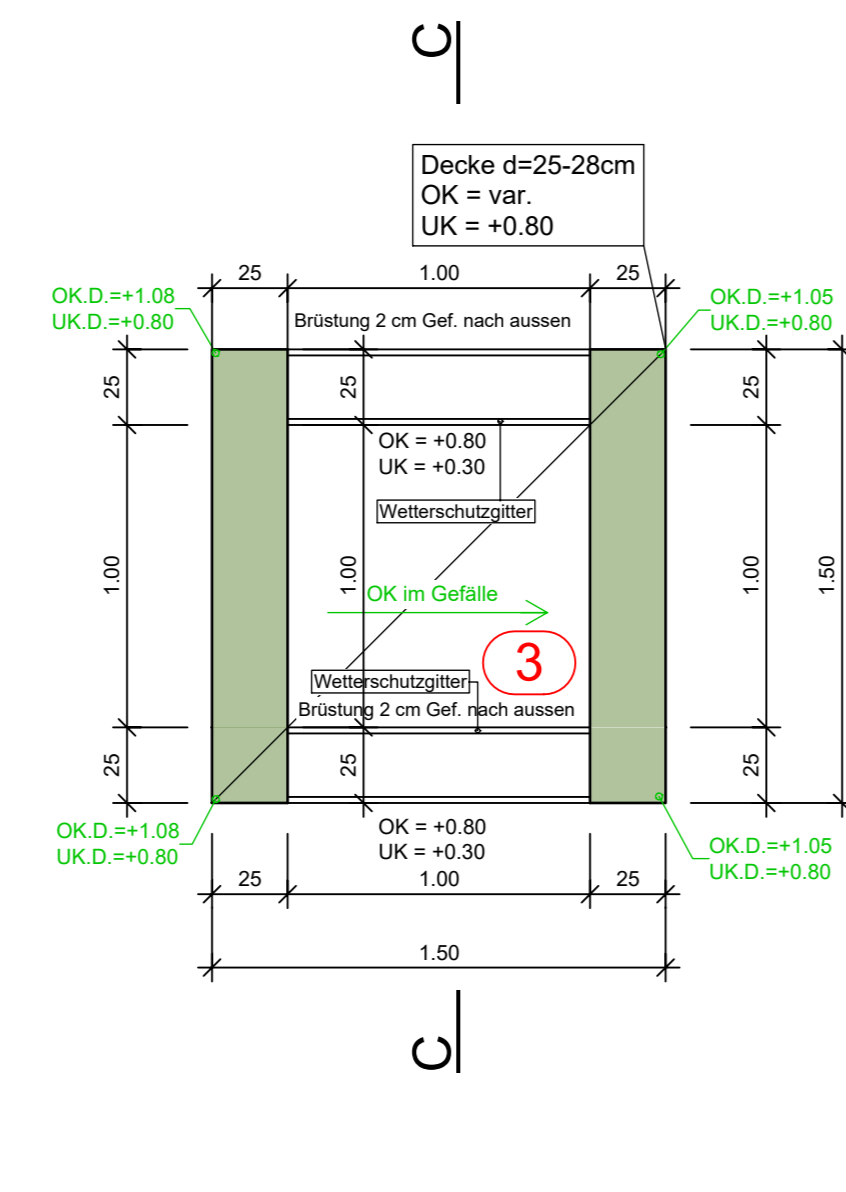

GRUNDRISS 1:25 Nachstromöffnungen "4"

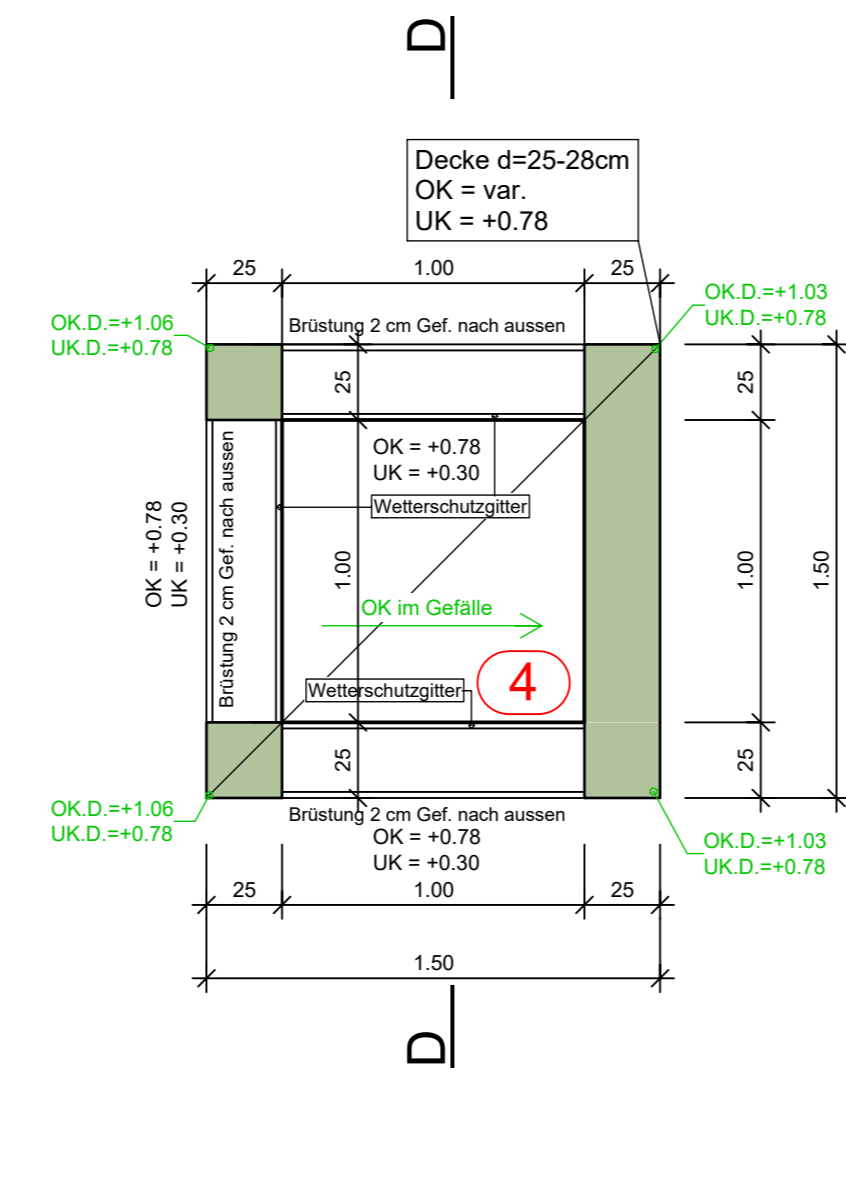

GRUNDRISS 1:25 Nachstromöffnungen "5"

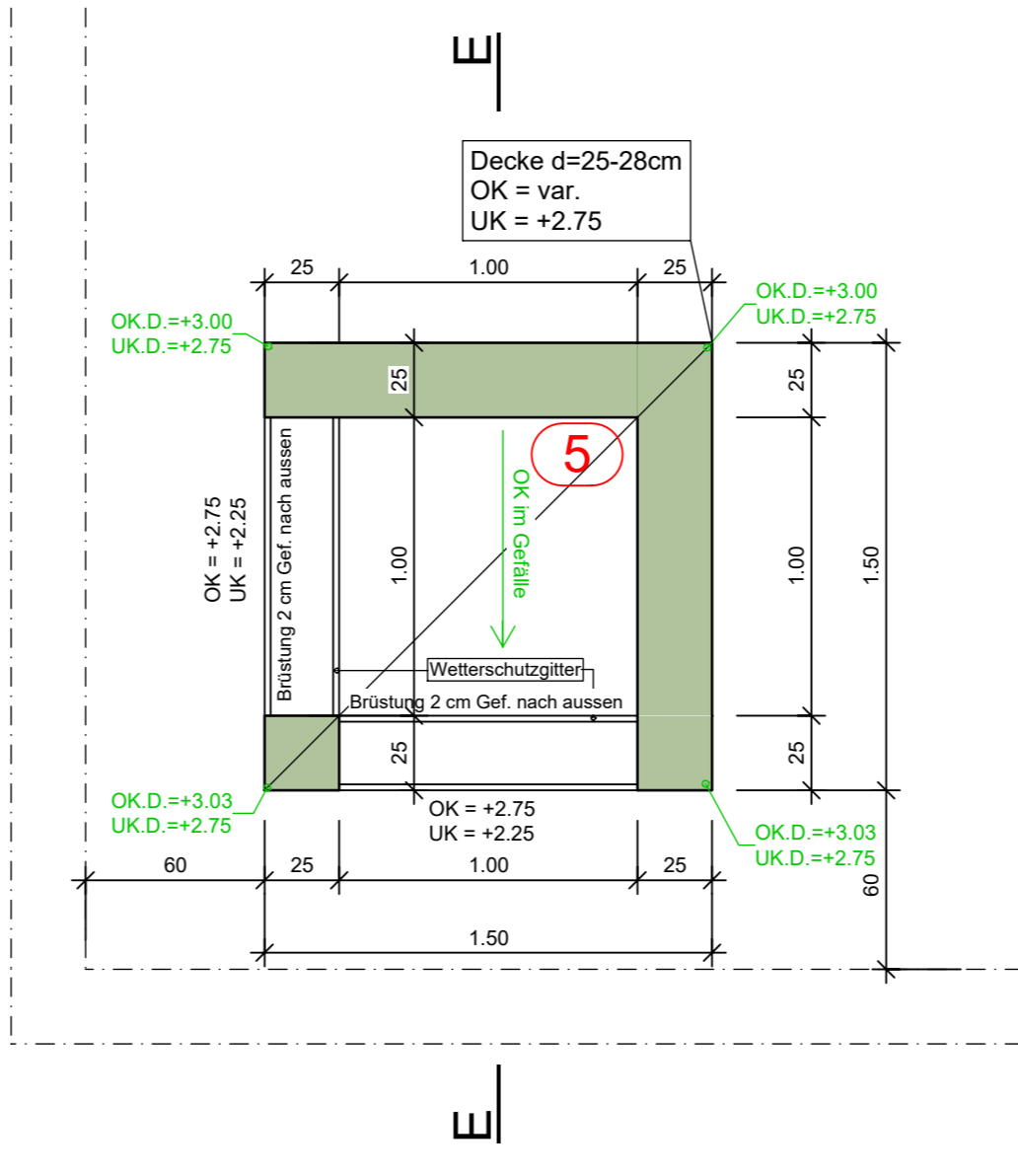

SCHNITT 13-13, 1:50

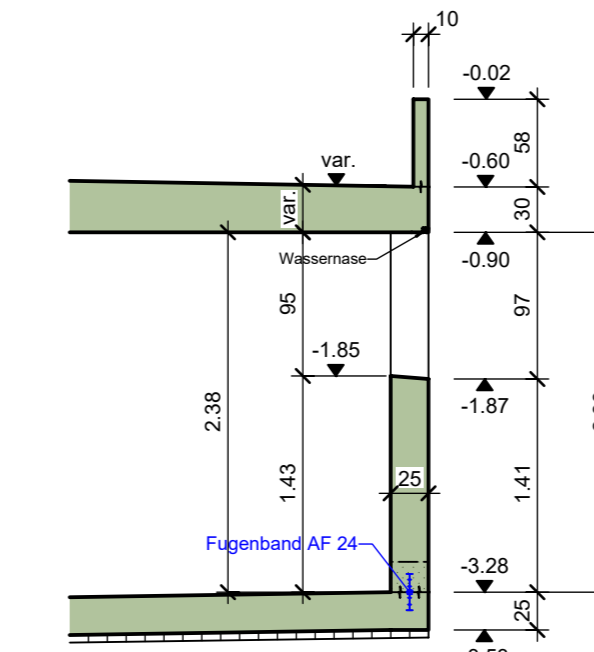

GRUNDRISS, 1:200 Dämmung

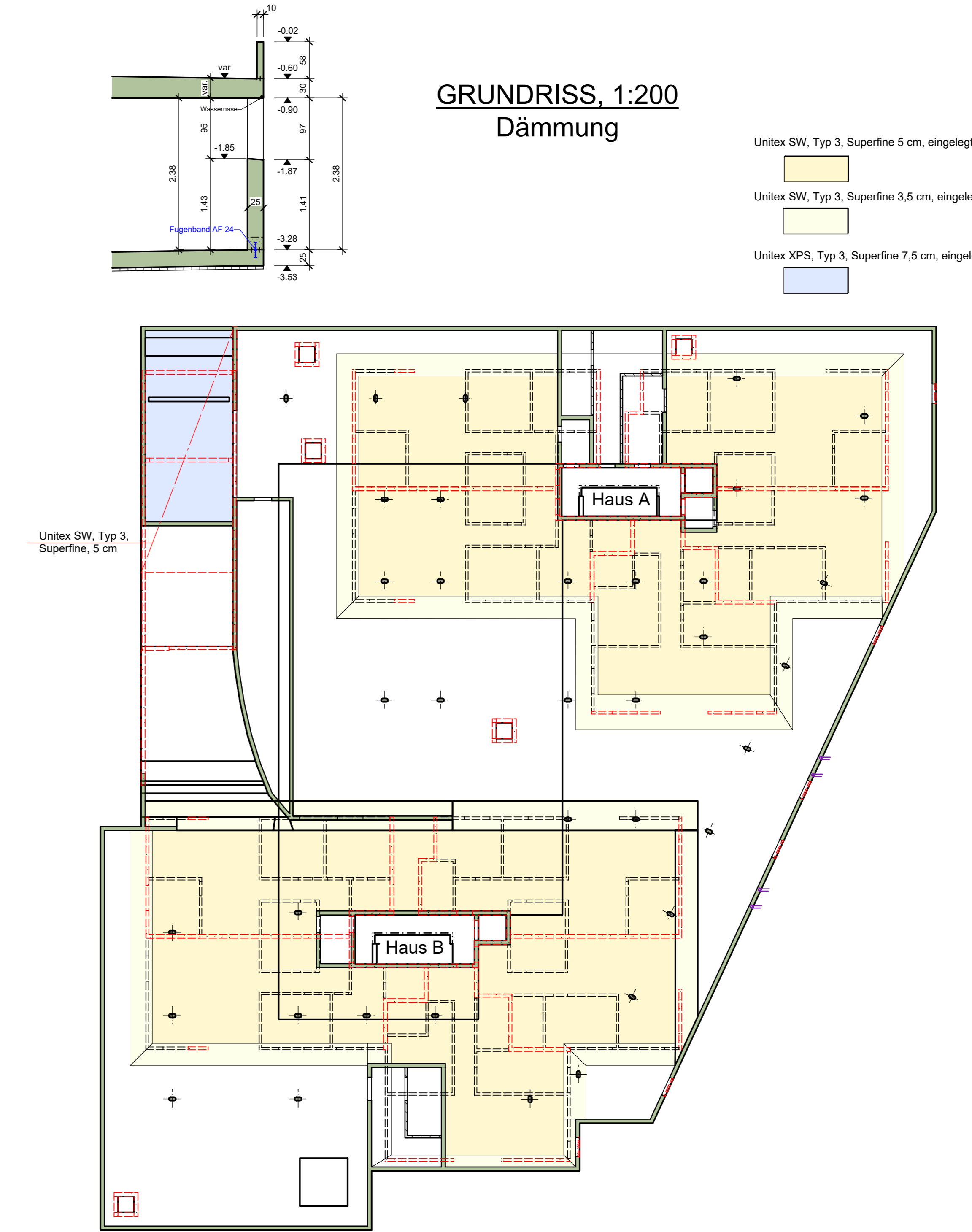

SCHNITT A-A, 1:50

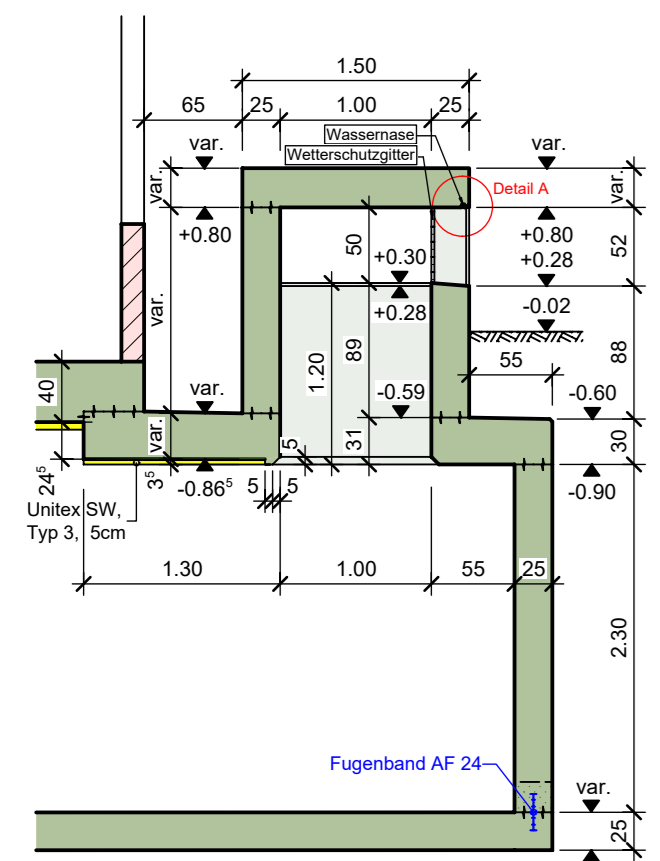

SCHNITT B-B, 1:50

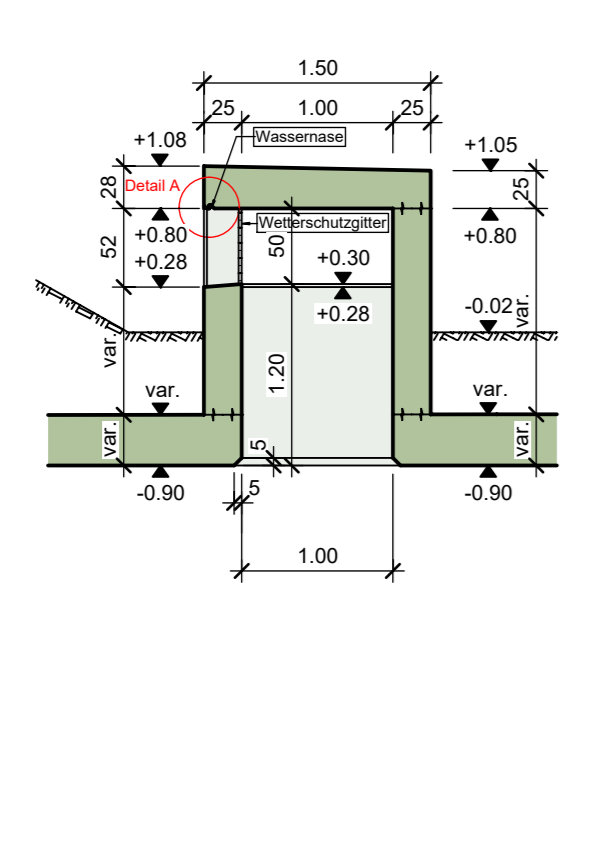

SCHNITT C-C, 1:50

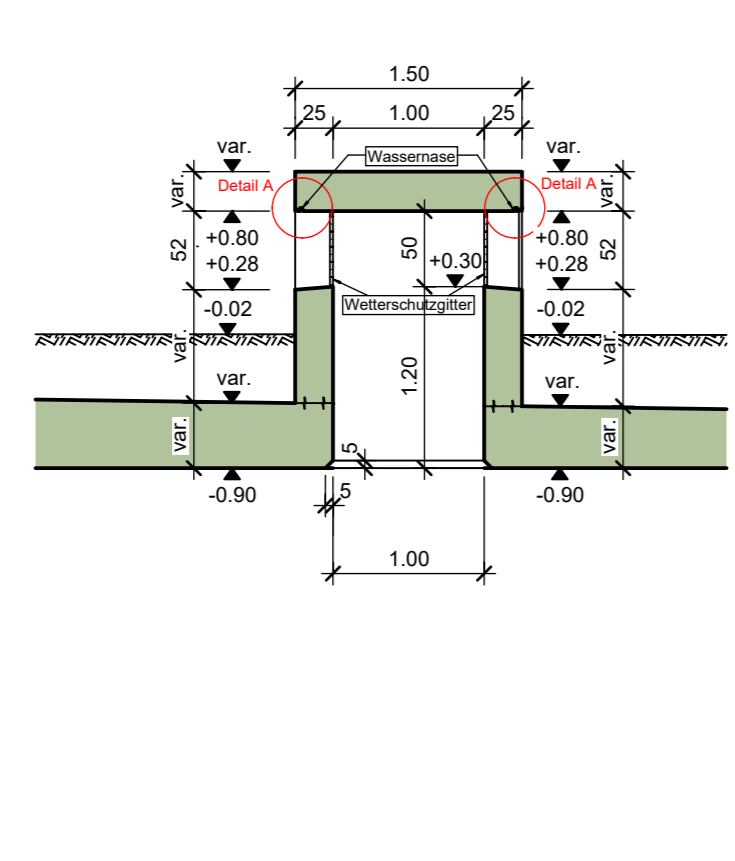

Detail A 1:25 Wassernase

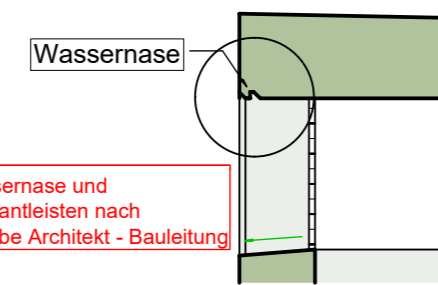

SCHNITT D-D, 1:50

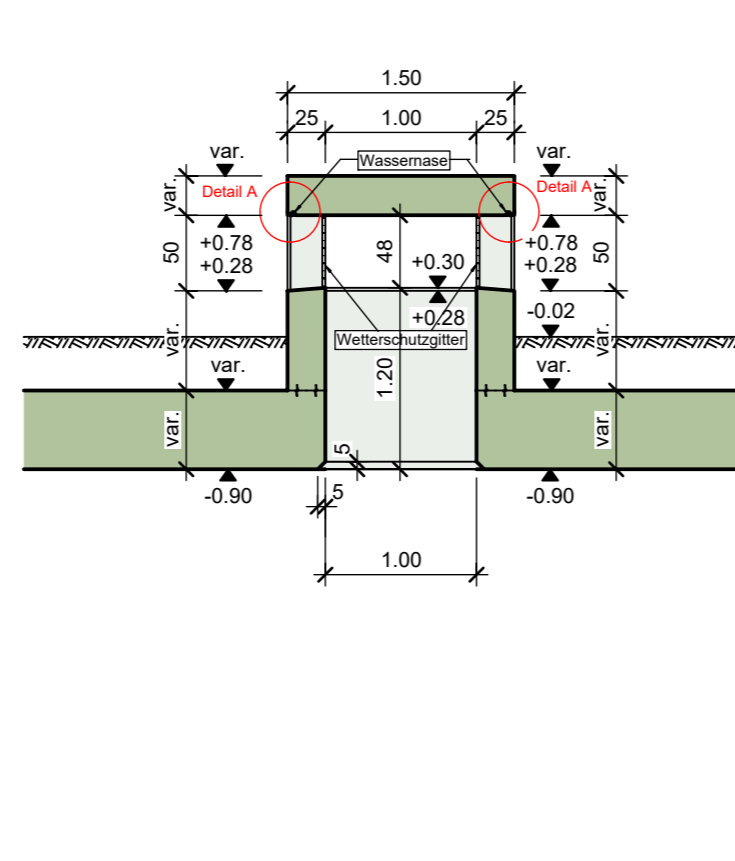

SCHNITT E-E, 1:50

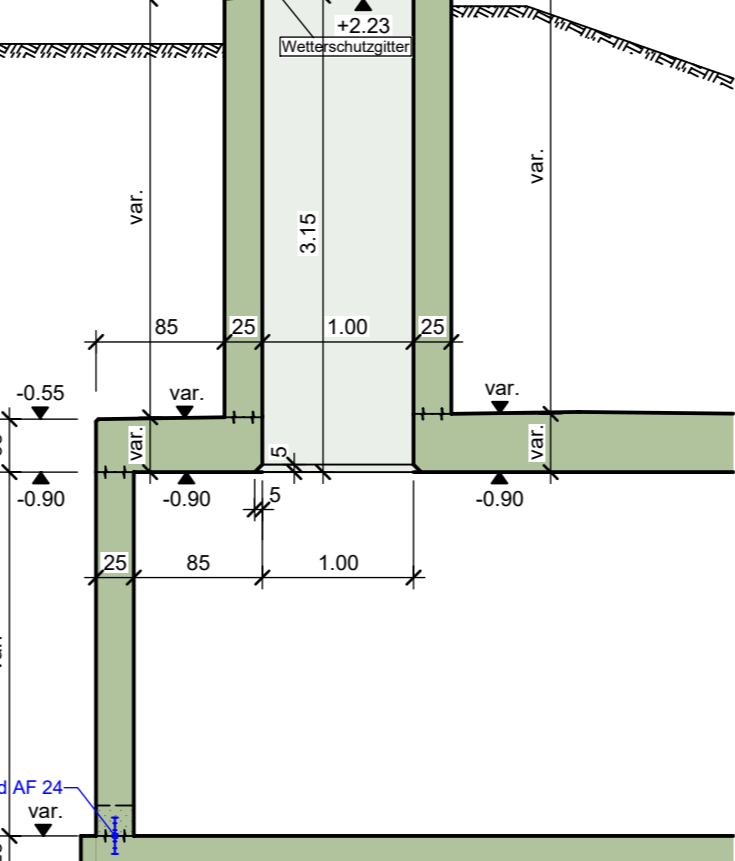

GRUNDRISS, 1:10 Stütze 1.UG

